

6SD

6FT PENT SHED INSTRUCTIONS

SHEDFAST



Base Sizes

	<u>Width (mm)</u>	<u>Length (mm)</u>
<u>6x6</u>	1790mm	1878mm
<u>6x8</u>		2478mm
<u>6x10</u>		3078mm
<u>6x12</u>		3673mm
<u>6x14</u>		4273mm
<u>6x16</u>		4868mm

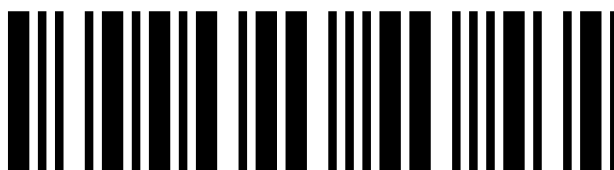

AS338



Introduction

Warranty -

Your Shedfast shed is guaranteed for two years against faulty manufacture as long as you treat it within two weeks of assembly with our recommended treatment. The guarantee would supply replacement planks or parts for any defective items (ie rarely a full panel) for self installation. Wind damage, non-domestic use, accidental or deliberate damage and Labour are all excluded from the guarantee.

Care and Maintenance-

Your Shedfast shed is made from good quality Scandinavian timber and should give you years of reliable use. However it is important to be aware of the natural properties of wood and accept these changes as they crop up on your shed. This kind of timber is affected by humidity which expands the timber as it gets wetter and shrinks it as it dries out. For this reason it is highly beneficial to treat your shed immediately when it is assembled with a good quality wood treatment. We offer the Shedfast original larch colour in a 2.5l can and you should use this if you want to keep a similar colour to the original. Alternatively, if you want to paint your new building in a coloured finish, then we offer the Protek Royal exterior which is a superb quality coating.

Although your shed comes with a factory applied premium protector treatment, the benefits of hand painting the shed immediately with one of our recommended treatments are so profound that we will only activate the 2 year warranty if your shed is coated with one of our recommended treatments within 2 weeks of assembly.

Please be aware that timber is a natural product and can split, warp, cup, expand and contract, leech sap, shed knots, shake and twist. These matters can be mitigated by applying a treatment immediately when you get your shed and by filling shakes, splits and knot holes as they crop up as a part of your ongoing maintenance. Check your shed annually and fill any defects that have developed.

Safety information-

- Glass and timber can potentially cause injury. Please ensure you wear protective goggles, gloves, headgear and suitable footwear when assembling the building.
- Please remember that glass is fragile and should be handled with extreme care. Always clear up and dispose of any breakages immediately.
- Do not assemble the shed in high winds.
- For safety reasons and ease of assembly when self-assembling, we recommend that this shed is assembled by two people.
- Please clear all lying snow from the shed roof as it can cause the roof to buckle or collapse.
- Please do not stand directly or put your whole body weight on the roof.

Site preparation-

- When selecting a site for your shed, it is vital that you choose as flat and level an area as possible.
- A concrete or slabbed base will provide the most solid foundation for your shed. It is important the base is level.
- Avoid placing your shed under trees or in other vulnerable locations if possible.
- To minimise the risk of wind damage, try to select as sheltered a site as possible, e.g. beside a hedgerow or garden fence.

Tools required-

- Drill
- Spirit Level
- Knife
- Ladders
- Hammer
- Screwdriver
- Tape Measure

Pre Assembly

- Before you start, check you have all the correct components required for the build. See the tables on the back pages to check this.
- Remove any of the transit blocks, but be careful when laying the panels down to not snap any of the over-hanging cladding.

Doors-

Please ensure that your door is securely fastened in windy conditions to prevent damage to the hinges or door posts.

Felt-

Your shedfast building comes with a good quality polyester backed felt which is harder to rip than regular shed felt. Keep an eye on your felt as a part of your ongoing maintenance and repair or replace it promptly if it deteriorates (for example after a storm) before water has chance to get in and damage the shed.

Base Sizes

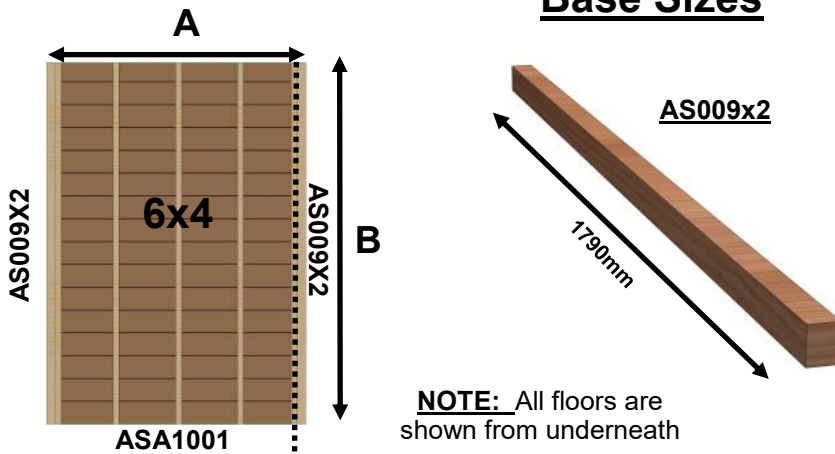

Panels	Size	Quantity
ASA1001	1195x1790	1
AS009X2	44x56x1790	2

Length (A)	Width (B)
1283mm	1790mm

NOTE: The shed itself overhands the floor so add approx. 30mm

Panels	Size	Quantity
ASA1001	1195x1790	1
ASA1024	600x1790	1
AS009X2	44x56x1790	2

Length (A)	Width (B)
1878mm	1790mm

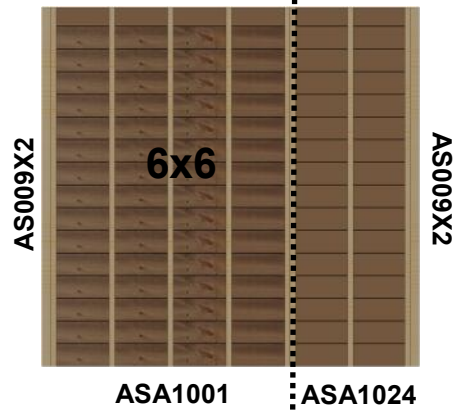

Panels	Size	Quantity
ASA1001	1195x1790	2
AS009X2	44x56x1790	2

Length (A)	Width (B)
2478mm	1790mm

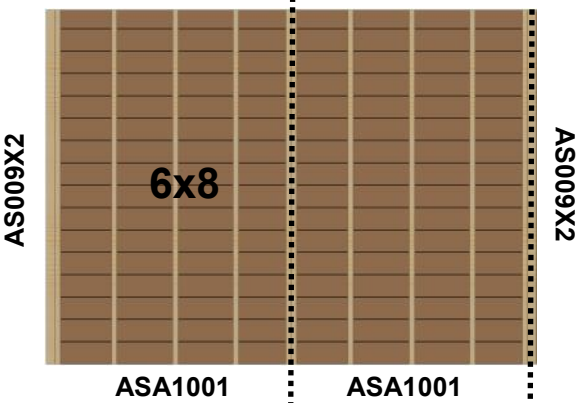

Panels	Size	Quantity
ASA1001	1195x1790	2
ASA1024	600x1790	1
AS009X2	44x56x1790	2

Length (A)	Width (B)
3078mm	1790mm

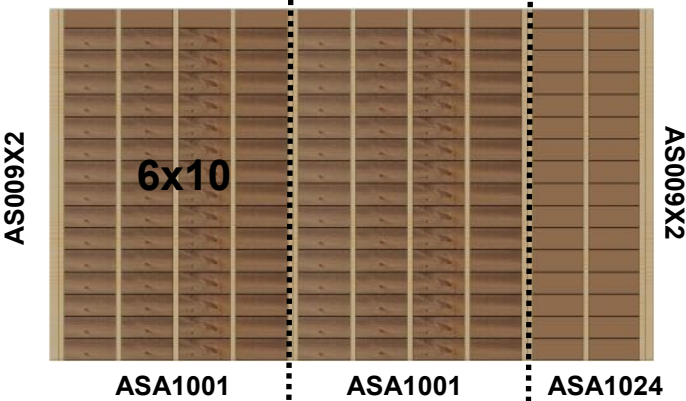

Panels	Size	Quantity
ASA1001	1195x1790	3
AS009X2	44x56x1790	2

Length (A)	Width (B)
3673mm	1790mm

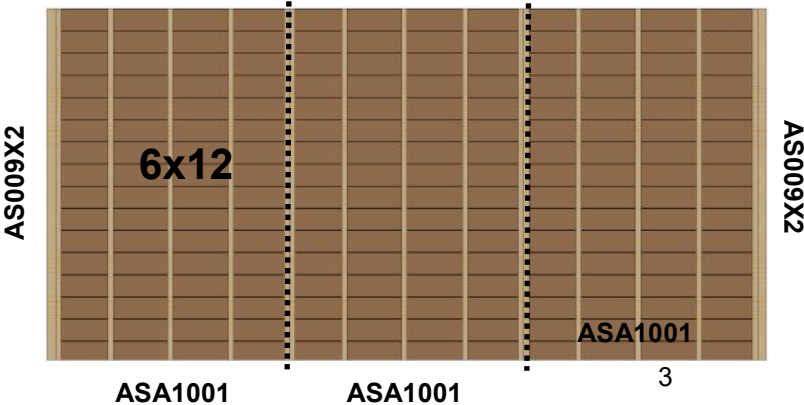

Shed Base System (Optional)

The base system is made up of sections that mirror the size of the floor panels . Finally, at each end you need to add an extra batten (AS108) to make the length up.

<u>SHED SIZE</u>	<u>AS103 (300mm)</u>	<u>AS104 (512mm)</u>	<u>AS105 (1107mm)</u>	<u>AS106 (1195mm)</u>	<u>AS107 (1490mm)</u>	<u>AS108 (1790mm)</u>	<u>80mm Screws</u>
6x4	6	0	4	0	0	4	46
6x6	9	4	4	0	0	6	76
6x8	9	0	8	0	0	6	76
6x10	12	4	8	0	0	8	106
6x12	12	0	12	0	0	8	106

6X4 Section

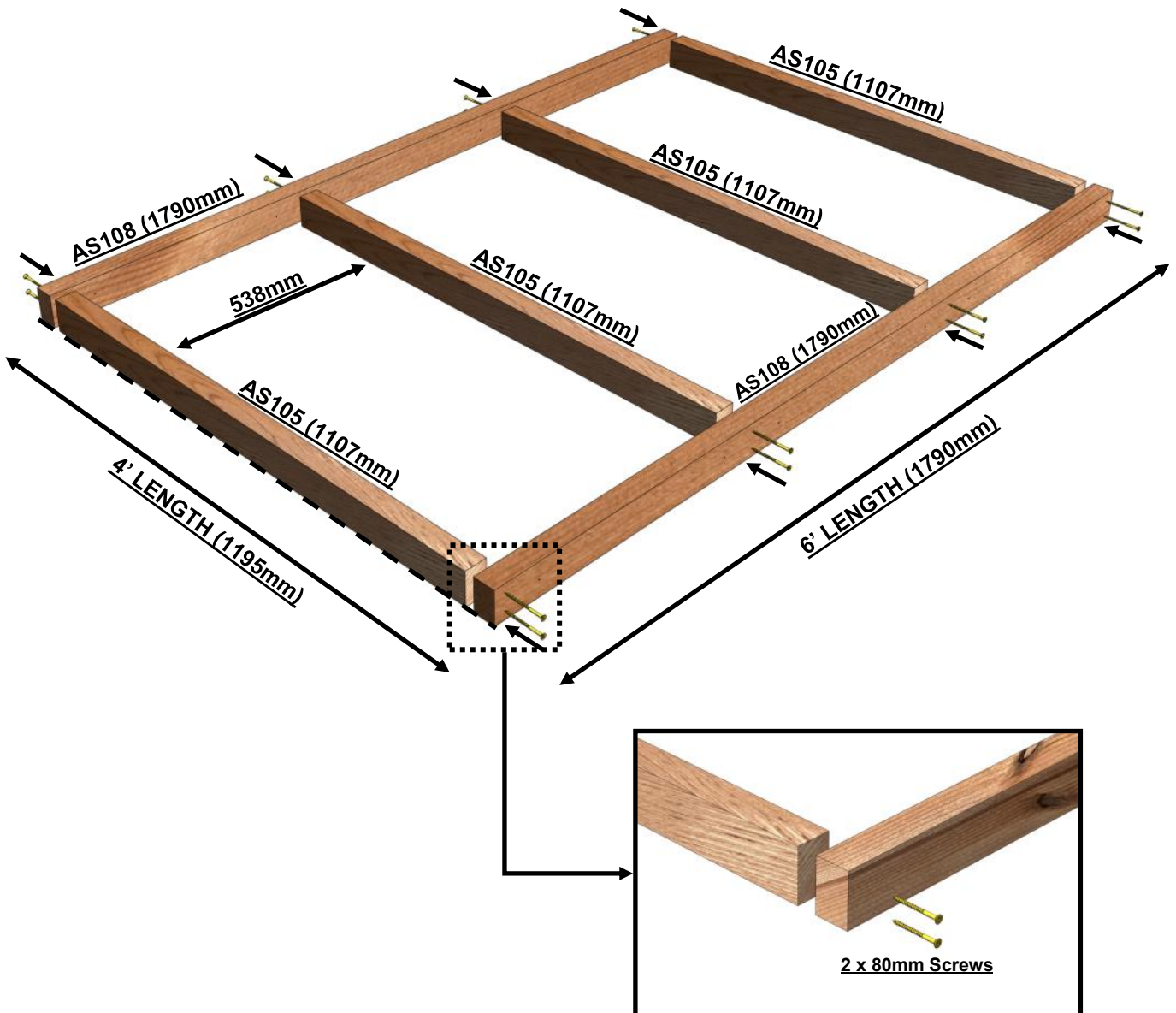

6X2 Section

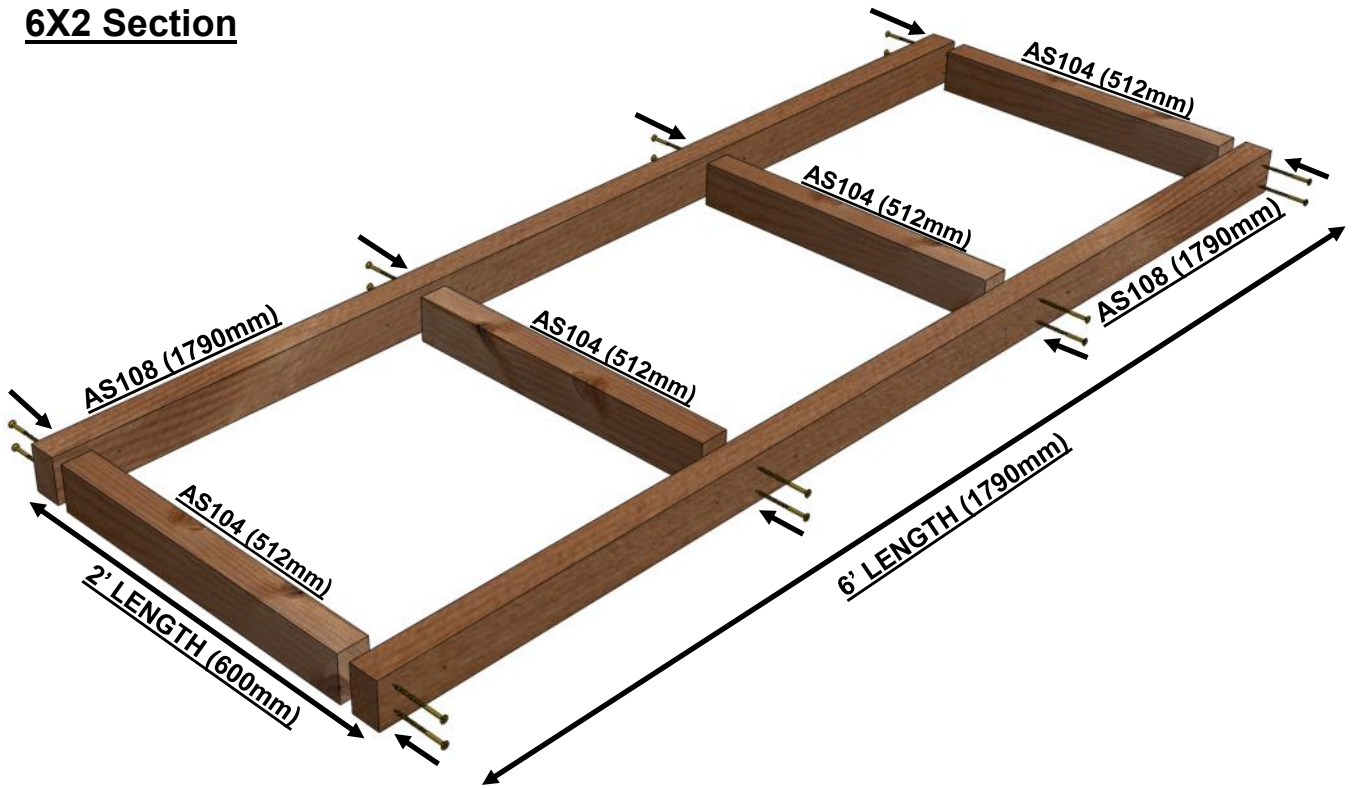

Once you have built your sections up, you need to add an extra AS108 baton on each end to make up the length

6x4 Example

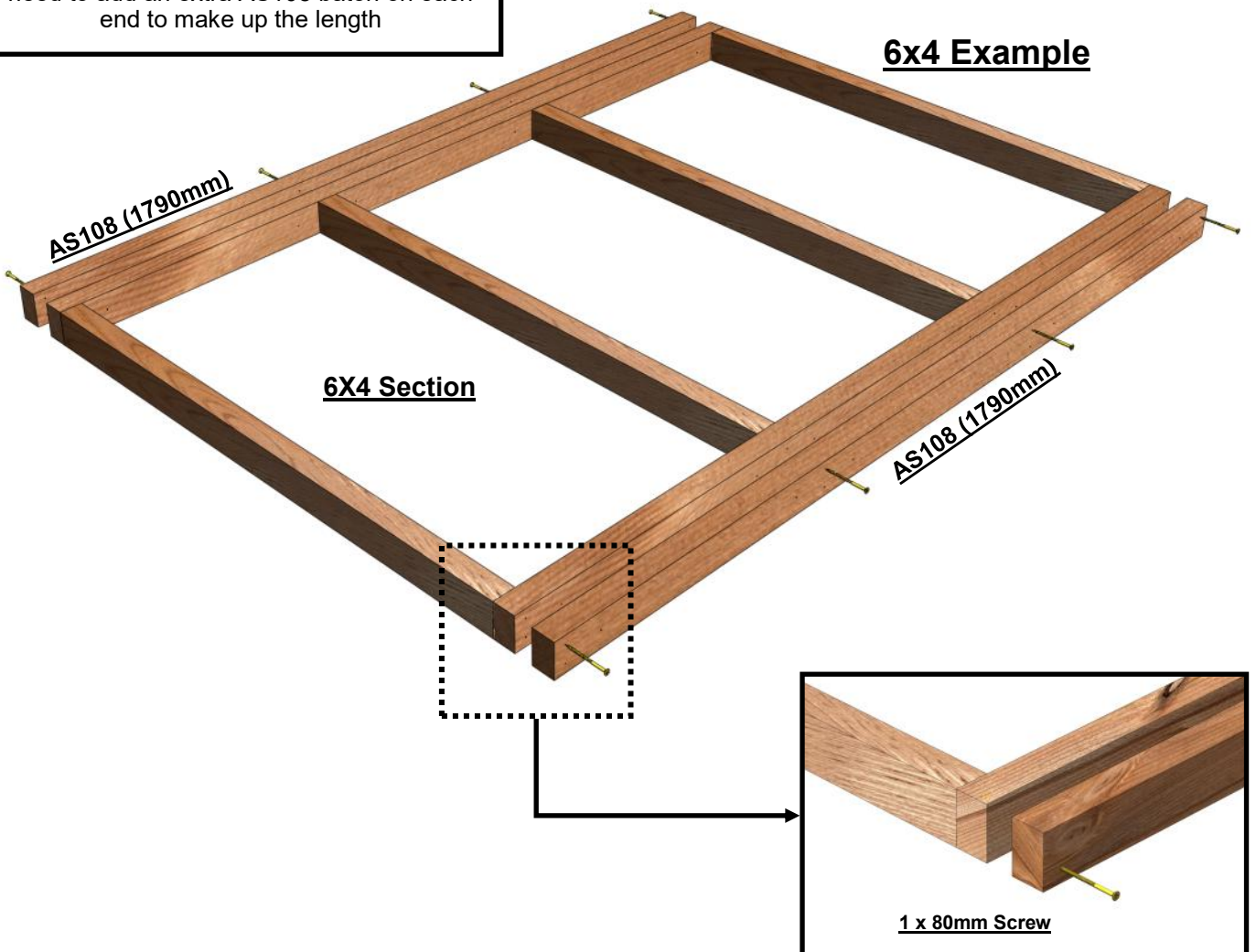

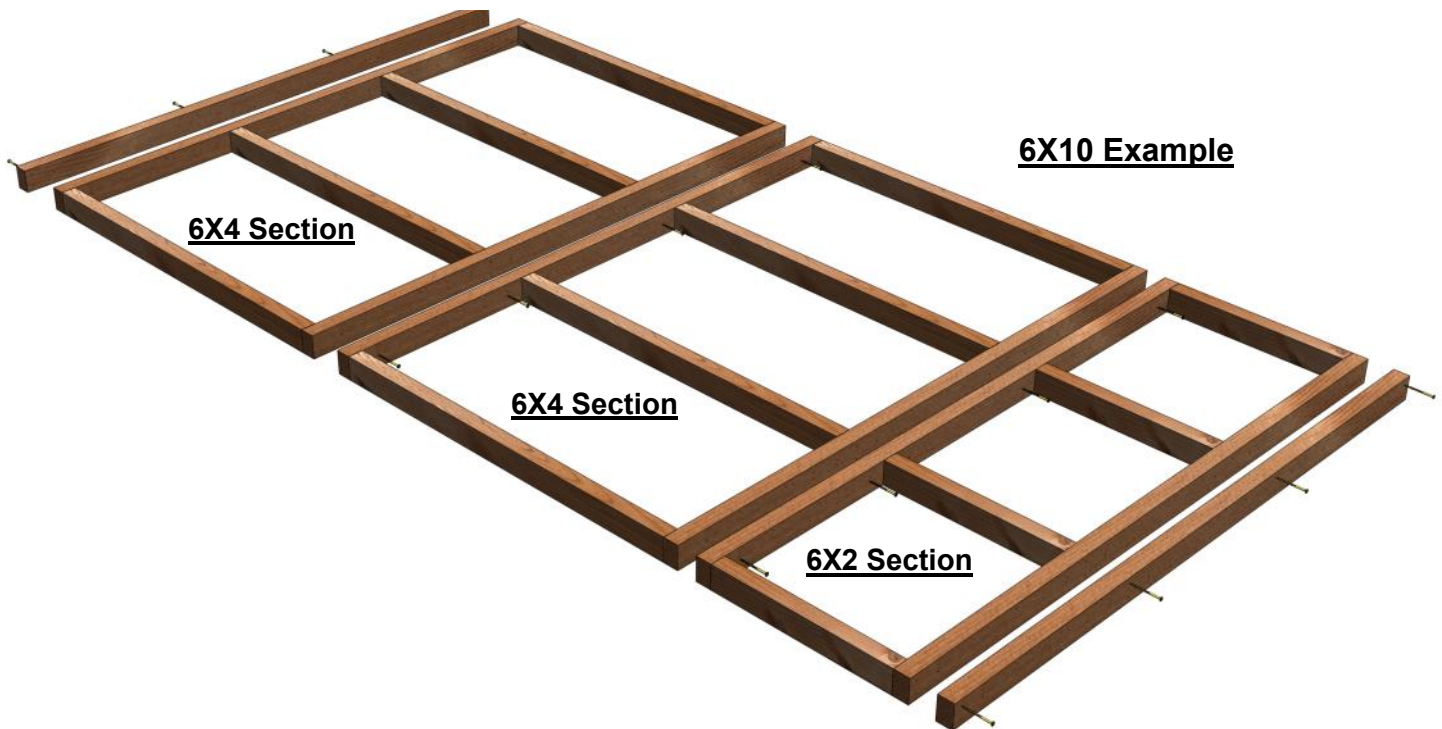
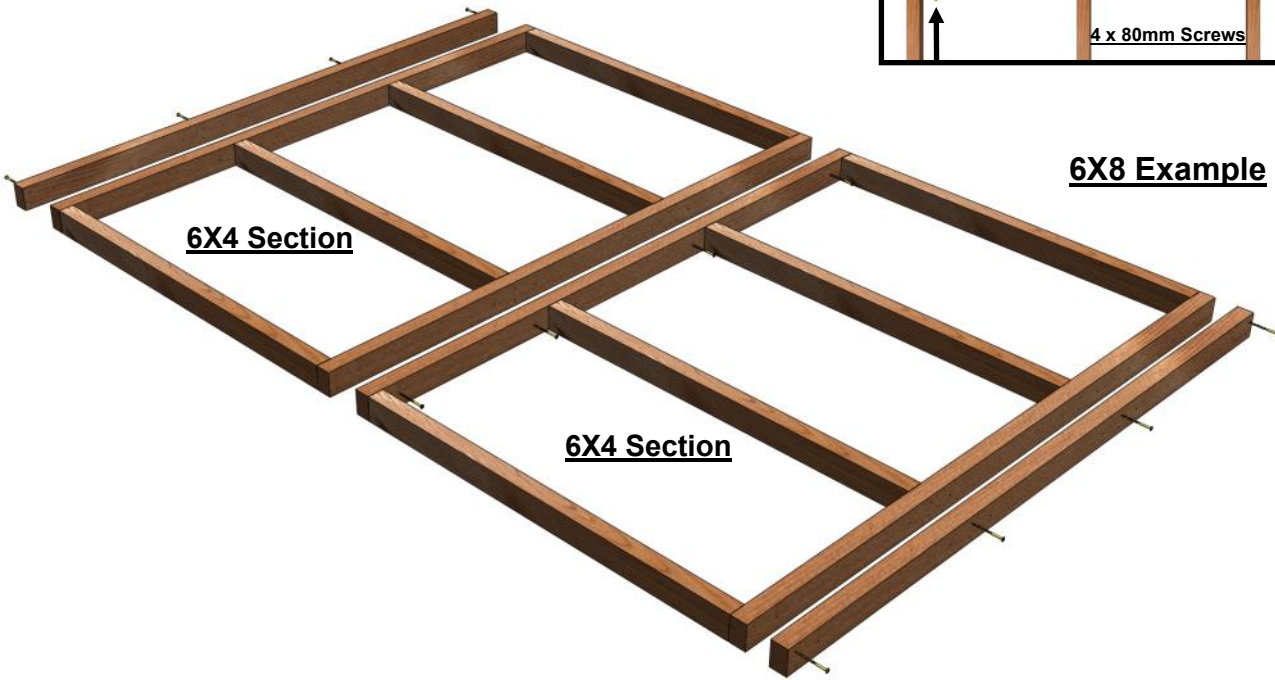
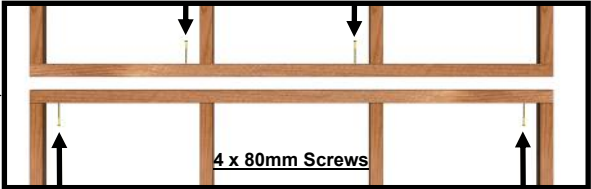
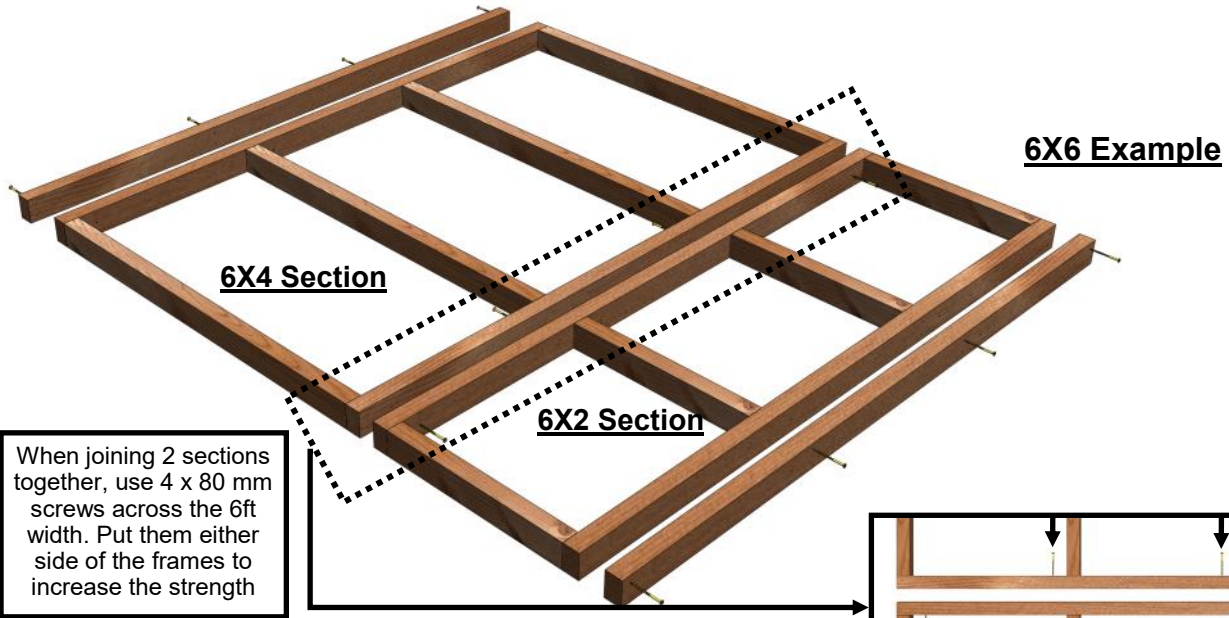

6X10 Example

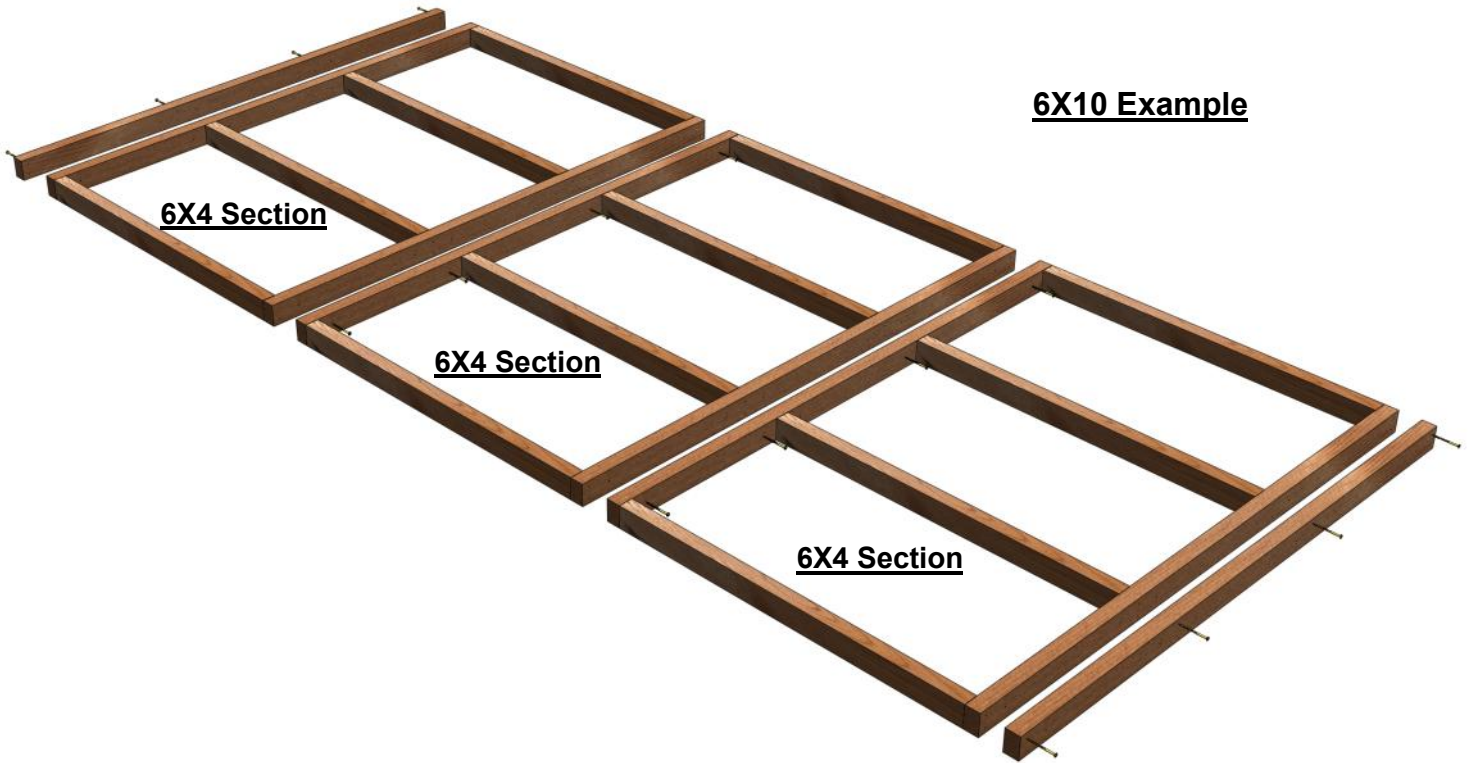

You will received **AS103 (300mm)** legs with your base. These are to help you level your base before you put the floor on top. You can either put the legs on vertically if you have a big gap to level and saw off the top, let the legs sit into concrete holes in the base below or lie the legs horizontally if you only have a small gap to level. Use a spirit level to ensure the level of the base. You can spread these around the corners of the base to get the best level possible.

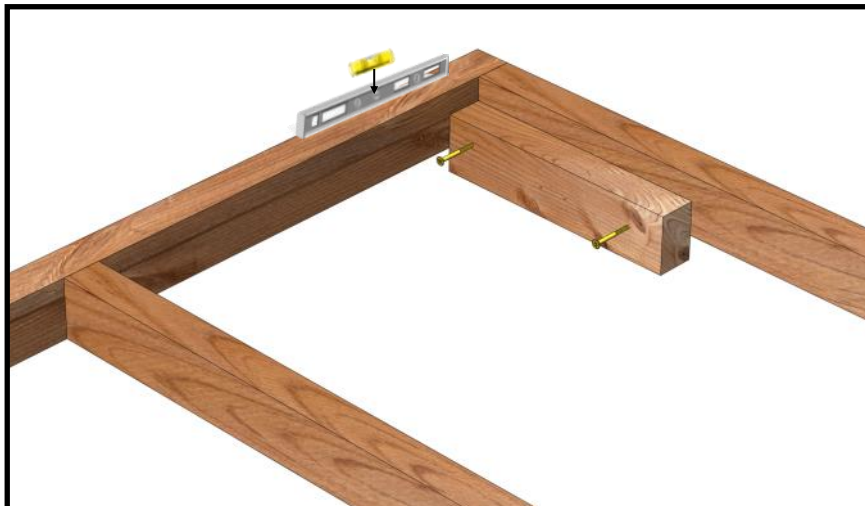
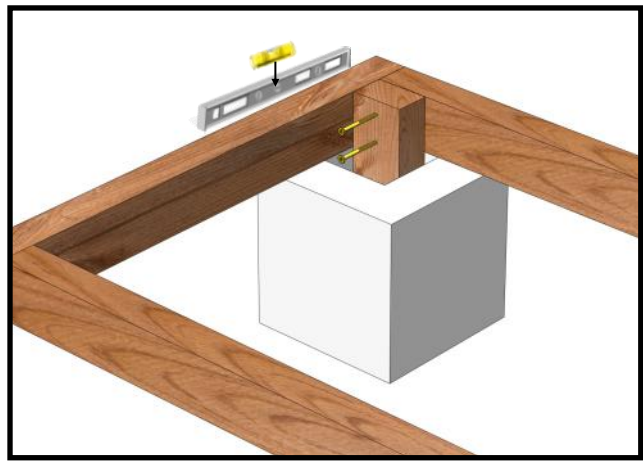
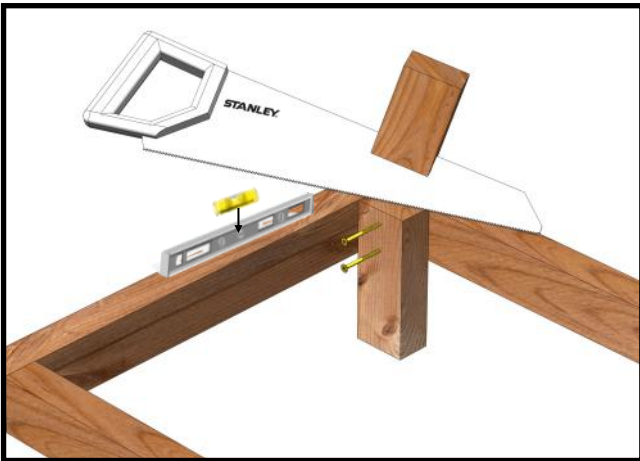

Panel Placement

Before you begin your build you need to decide where you would like your door and window panels. Because the panels are the same width, they are interchangeable. This means you can put the door, window and plain panels basically wherever you want. See below for an example of the 6x12 and a 6x14 with the door in the gables and the door on the sides. The gable door can go towards the left or the right (with the 2' infill panel either side) and that when the door is in the sides it can go in either position, left or right

NOTE: The door is ambidextrous, so simply turn it upside down to change the hinge side to have it opening whichever way you want.



6x12 Door in the gable

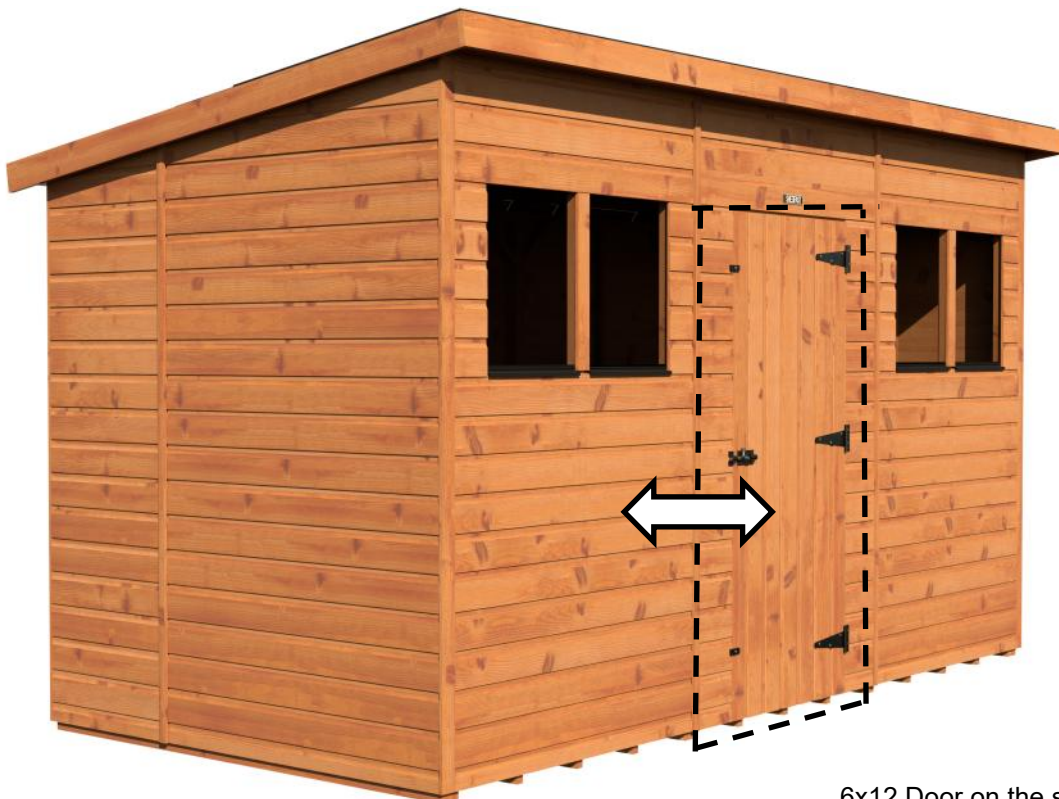

6x12 Door on the sides



6x14 Door in the gable

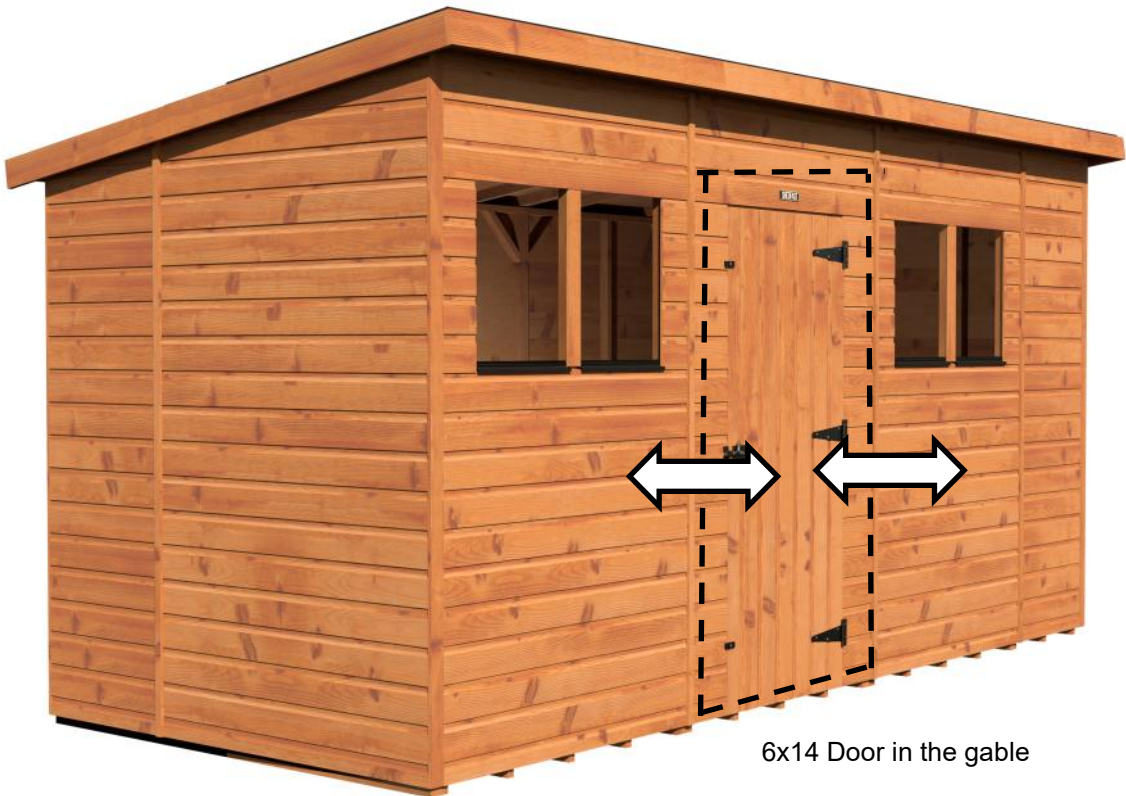

6x14 Door in the gable

Floor Assembly

Using **02-5001 Self drilling 60mm screws, AS009x2** to the ends as show on the diagram (right).

Screws every 2ft will be sufficient to keep the floor firmly held together

6x8 base example shown, for other sizes see table on page 3

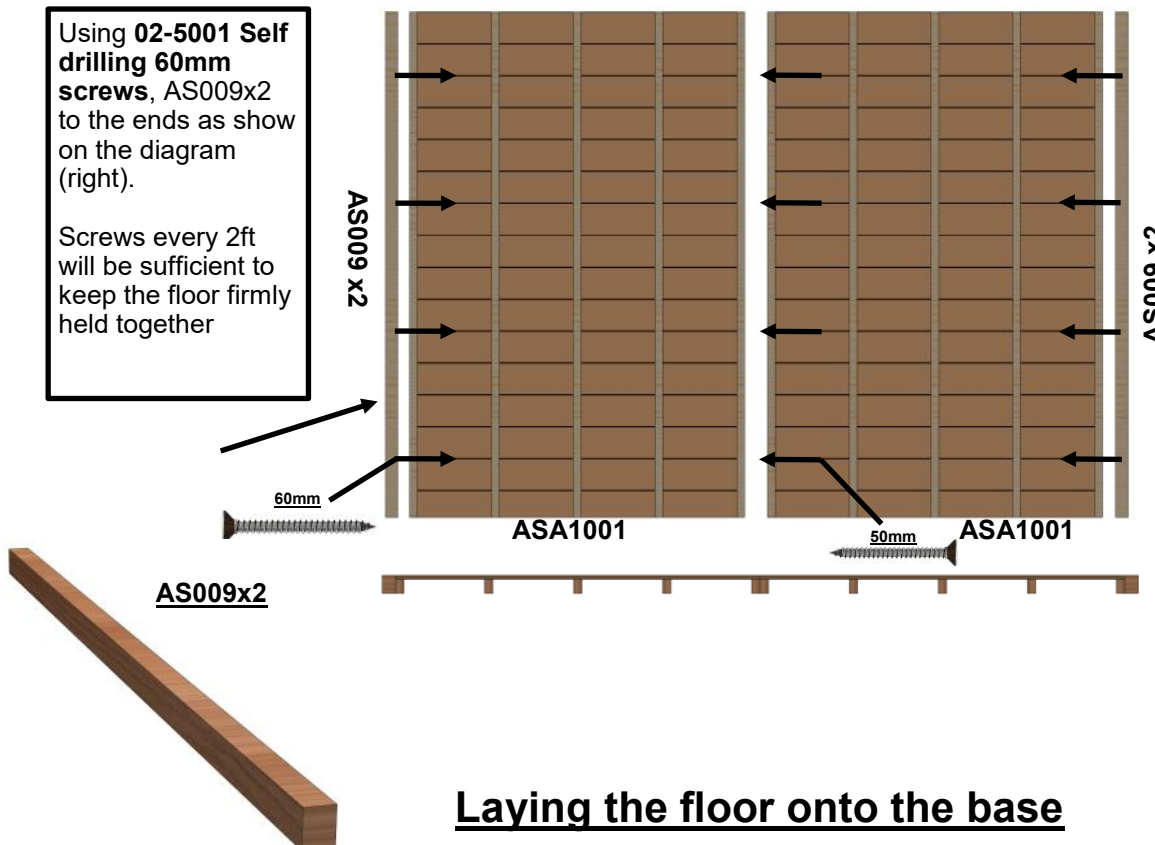

Laying the floor onto the base

Once you have assembled the floor you need to now lay this onto the base. Ensure the base is flat and level by using a spirit level. Then lay the assembled floor onto the base, once again checking that everything is flat and level.

A flat and level base is vital because if it is not level then you will experience problems such as the door not opening or closing properly, the roof not fitting properly and you may get gaps appearing. Use the spirit level across the width and length of the floor.

NOTE: Flipping the floor over and laying it onto the base should be done very carefully to avoid damage to the floor.

If you're building a floor that's 12ft or longer then you will have to screw the floors together when they're the right way or because it will be too big to flip. Use **50mm Screws and pilot drill** and screw from the top where the floors join and angle them so the screw goes through into both floors.



12ft or longer:

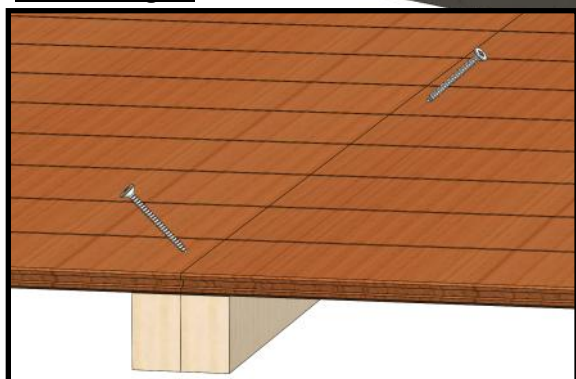

TIP:

Take time to make sure your original base + your wooden floor is level. The door will be affected if not level. If your concrete or slabs are uneven, you could consider ordering the optional Shedfast wooden base system.

Door Panel Assembly

PLEASE SKIP TO PAGE 12 FOR THE OPTION JUMBO DOUBLE DOOR

You can position the door panel more or less anywhere on the shed when assembling. At this stage you need to decide whether to hinge the door on the left or right. The door is ambidextrous, so simply turn it up-side down to change the hinge side.

Fit the door in the door panel by lying down, evening up the space and screwing hinges on using **35mm screws 02-1814**

Add toggle buttons and pad bolt using **35mm screws 02-1814**

Add the name plate using **13mm screws**

When screwing the lock on, make sure you line it up with the brace on the inside of the door (see dotted line below)

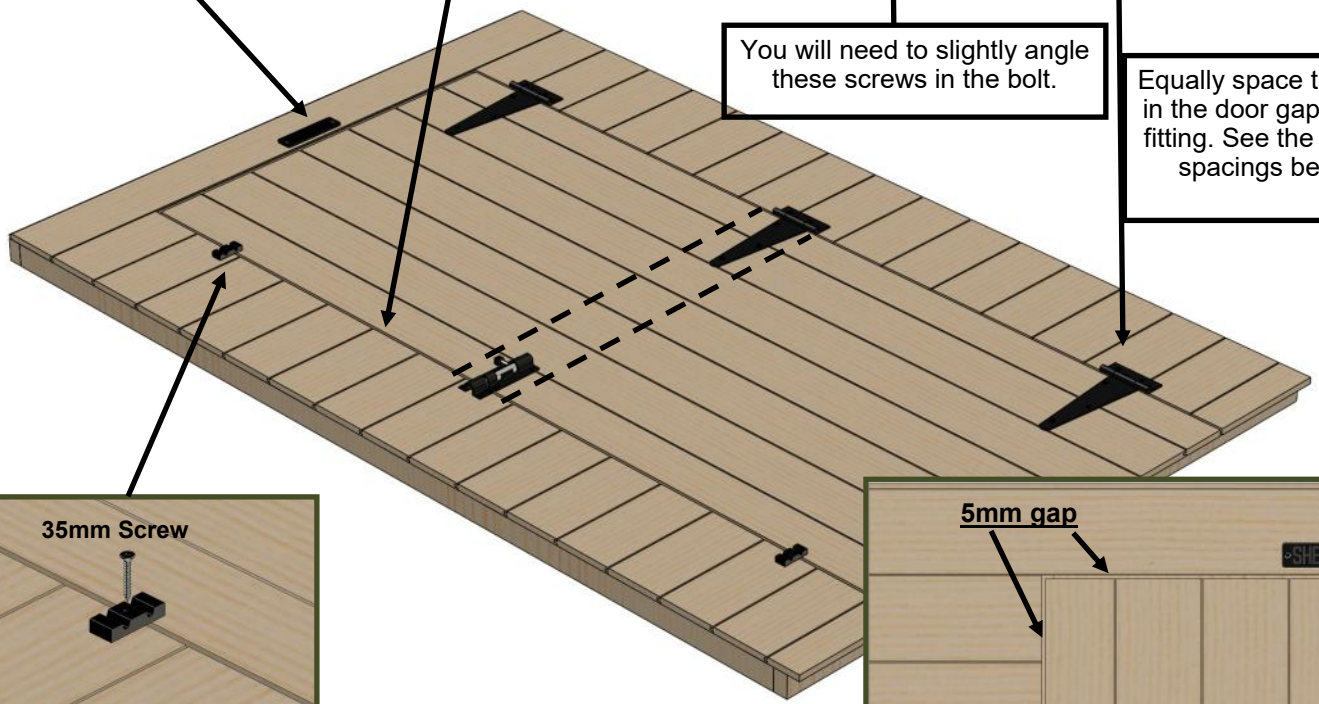
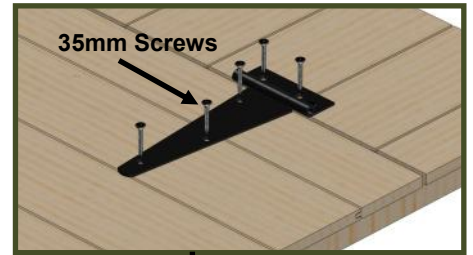
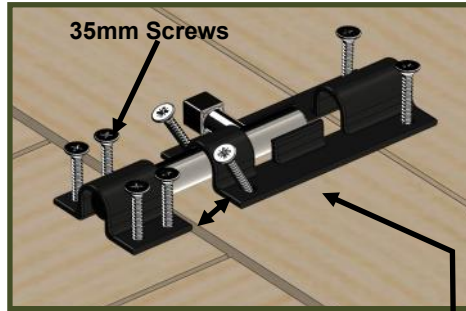
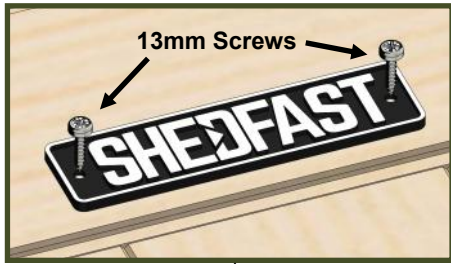

You will need to slightly angle these screws in the bolt.



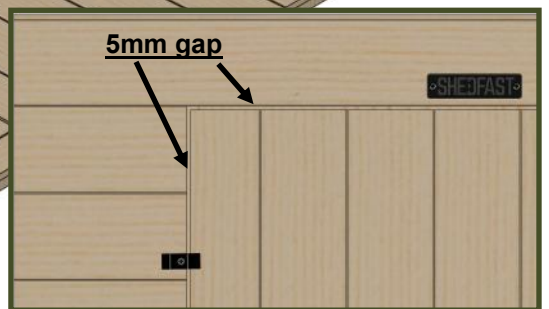
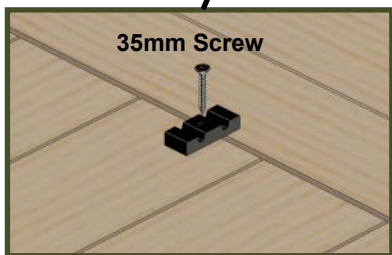



Equally space the door in the door gap before fitting. See the correct spacings below.



<u>Part Code</u>	<u>Quantity</u>
ASA1005 Single Door Panel 1200x1856	1
ASA1008 Single Door 740x1751	1
AS302 Hinges (already on the door)	3
AS303 Pad Bolt	1
AS304 Turn Button	2
AS306 'SHEDFAST' Name Plate	1

Double Door (Optional)

If you have the double door option for your shed, please follow the below instructions. If not, please skip to page 16 as this wont apply to you.

	<u>ASA1074 1.5ft RH Panel 486x1881mm</u>	<u>ASA1075 1.5ft LH Panel 486x1881mm</u>	<u>ASA1076 Door Header Panel 1476x140mm</u>	<u>ASA1008 Single Door 740x1751mm</u>	<u>AS303 Pad Bolt</u>	<u>AS127 Framing 44x44 1670mm</u>	<u>AS128 Framing 44x28 1467mm</u>
							
<u>QTY</u>	1	1	1	2	2	1	1

Removing the transit blocks

Before you start putting the sides onto the floor, you need to remove the transit blocks. They are nailed on to protect the overlapping cladding from snapping while in transit. Remove these blocks carefully using a hammer.



The double door option will spread over 8ft. You will get 1x ASA1074, 1x ASA1075 and 1x ASA1076 which attach together using **50mm wood screws**.

When attaching the sides together, use three **50mm wood screws** per vertical and ensure you make pilot holes with a 4mm drill bit.

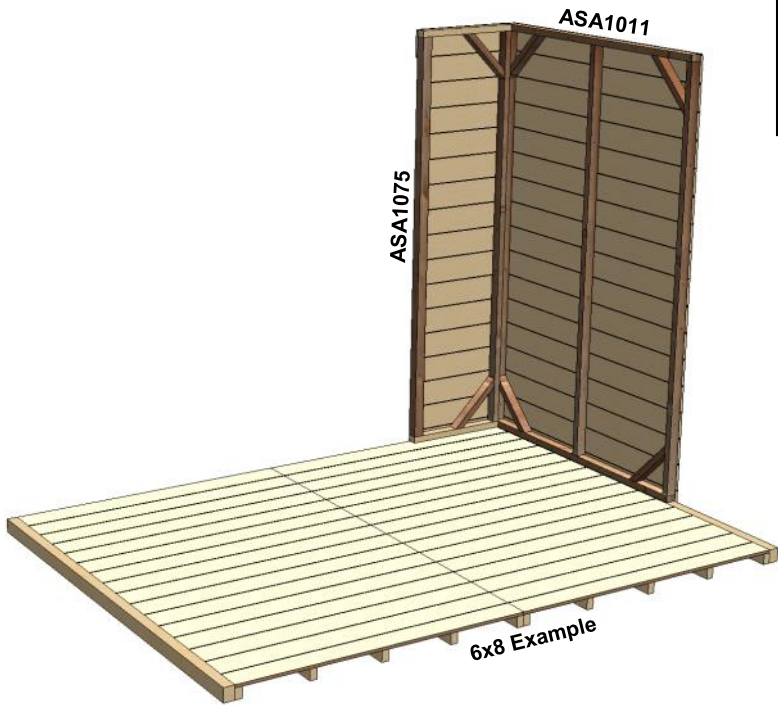

See how when the panels are lined up correctly, the cladding sits proud.

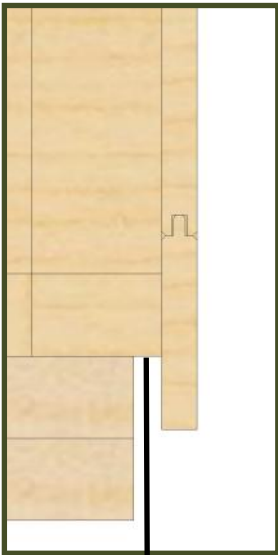

Allow for an approx. 5mm overhang between the floor and the side panel.

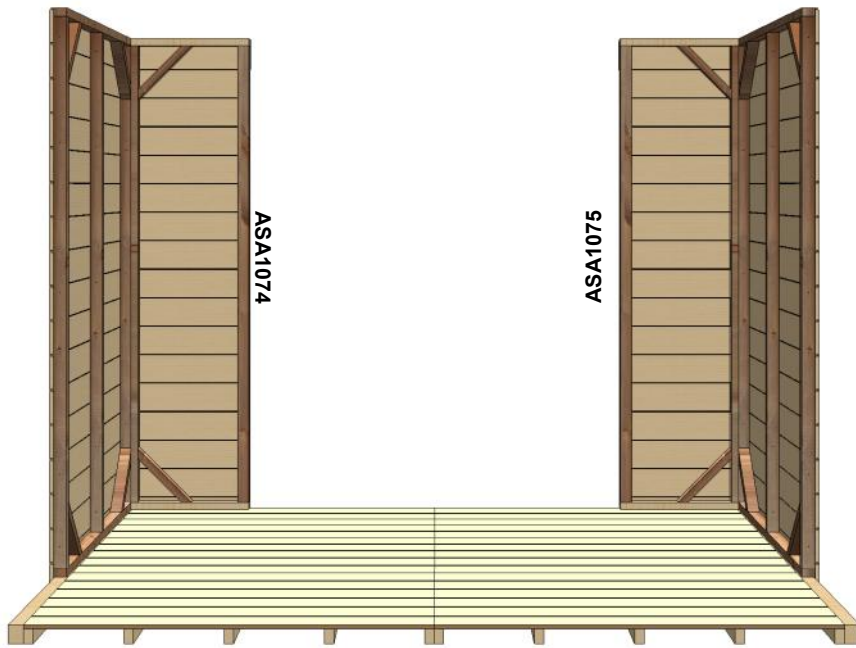

Repeat the previous steps on the opposite side so that you have a gap in between ready for the ASA1076 Above door panel.

You're now ready to put ASA1076 Above door panel in. Secure it to the ASA1074/75 1.5 panel with an **80mm screw**. Make sure it is flush with the top so the gable ASA1007 can sit properly on top. See the direction of the arrow for where to put the screw.

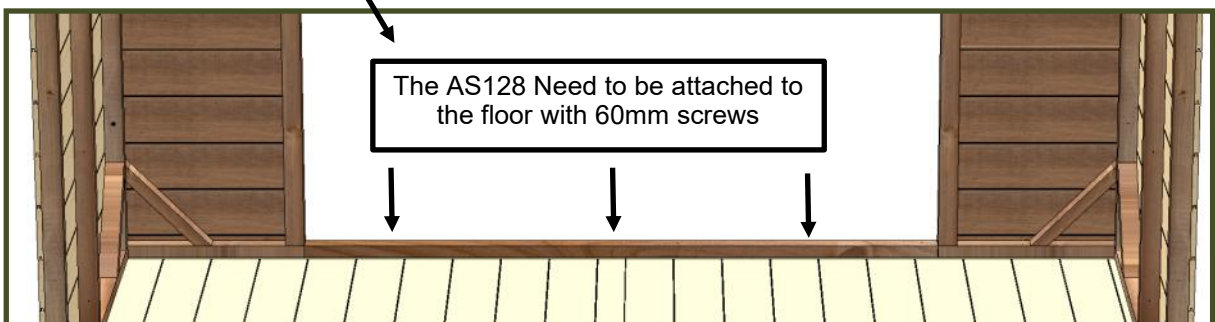
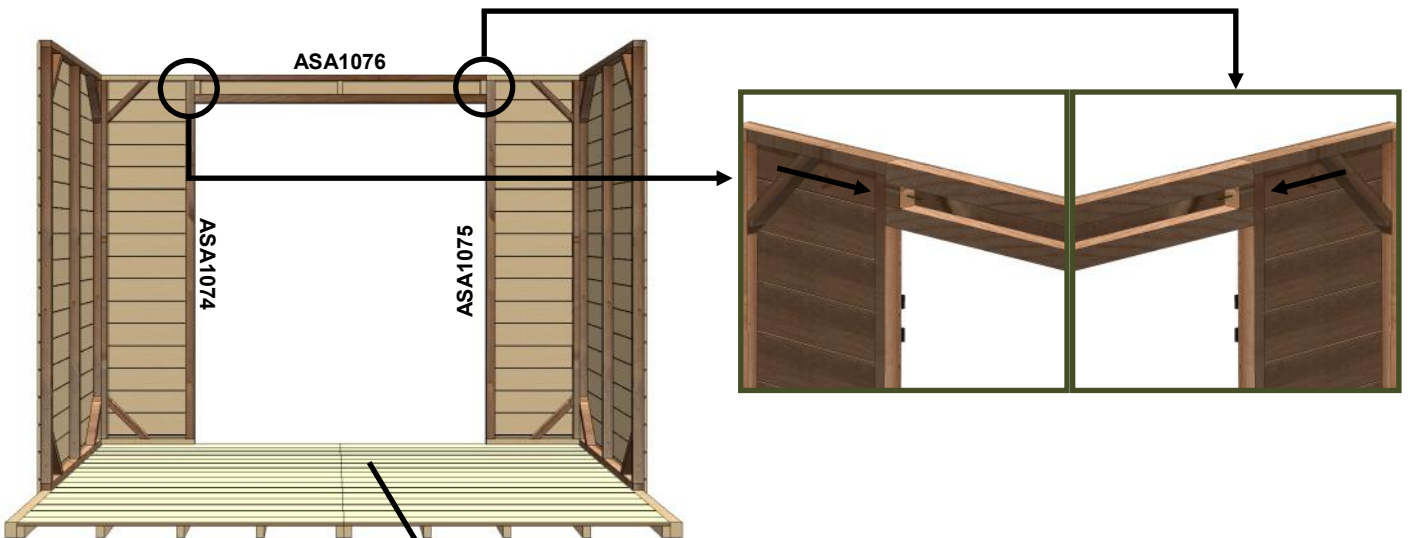

Refer to page 10 on how to install the doors into the door panels. With the double door option, you have to install the doors once the double door panel is actually fitted.

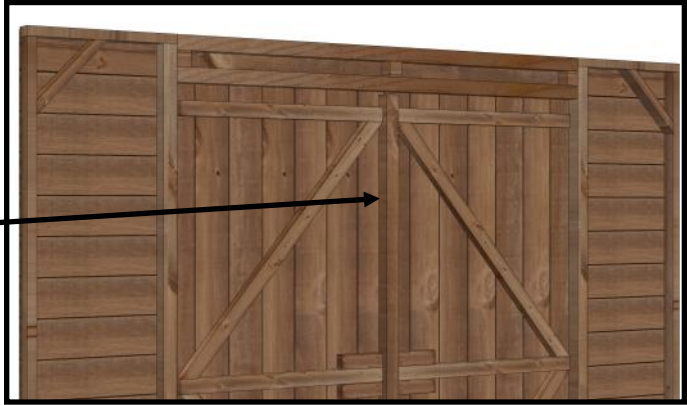

You now need to screw on the AS127 44x44 to the master door using 50mm screws.

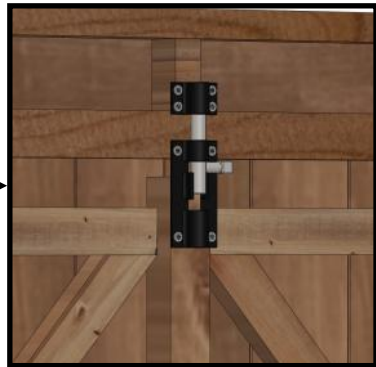

You will receive 2 x Pad bolts, these can be secured to the top and bottom of the AS127 that you screwed to the master door. This means that you can keep that locked. Use 35mm screws to secure these in place.



Sides Assembly

Removing the transit blocks

Before you start putting the sides onto the floor, you need to remove the transit blocks. They are nailed on to protect the overlapping cladding from snapping while in transit. Remove these blocks carefully using a hammer.

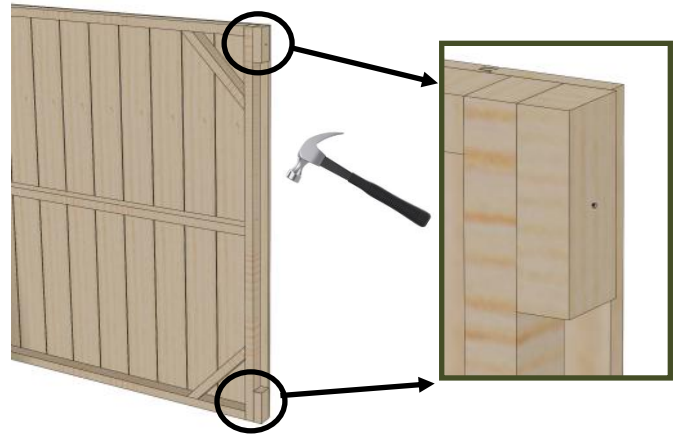

When attaching the sides together, use three **50mm wood screws** per vertical and ensure you make pilot holes with a 4mm drill bit.

NOTE: Because the plain, door and window panels are all the same size, you can position them wherever you want. There is no set order for them to be in, its totally your preference.

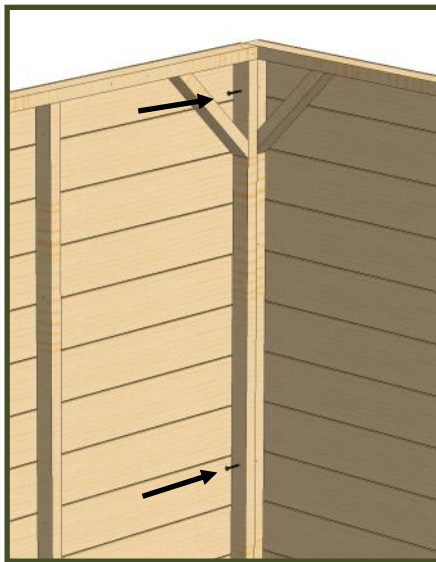

Pilot Hole size:

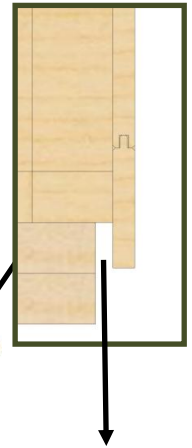
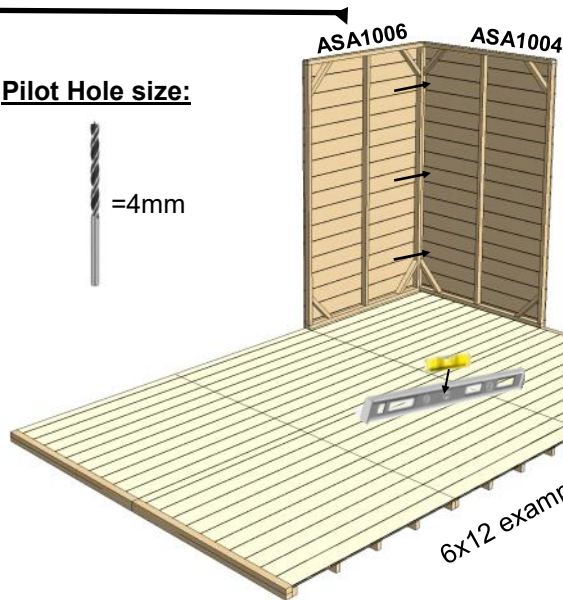

Allow for an approx. 5mm overhang between the floor and the side panel.

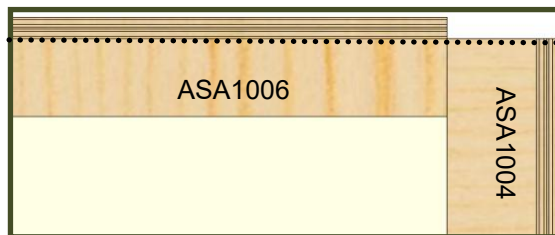
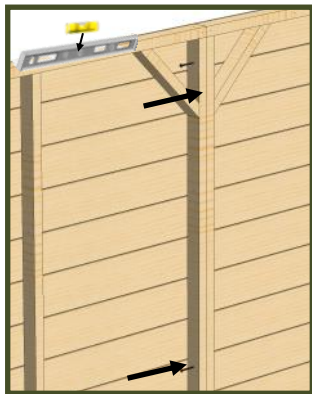

See how when the panels are lined up correctly, the cladding sits proud.

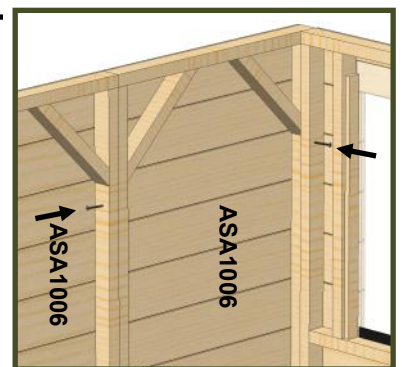
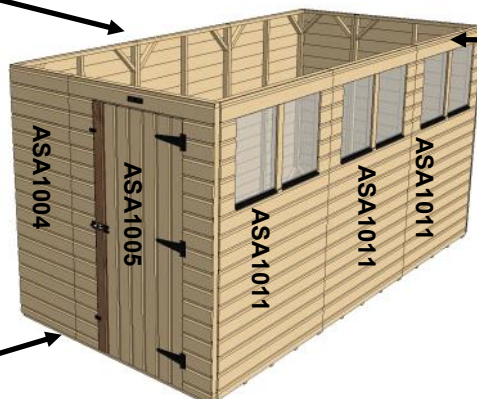

Top Panels

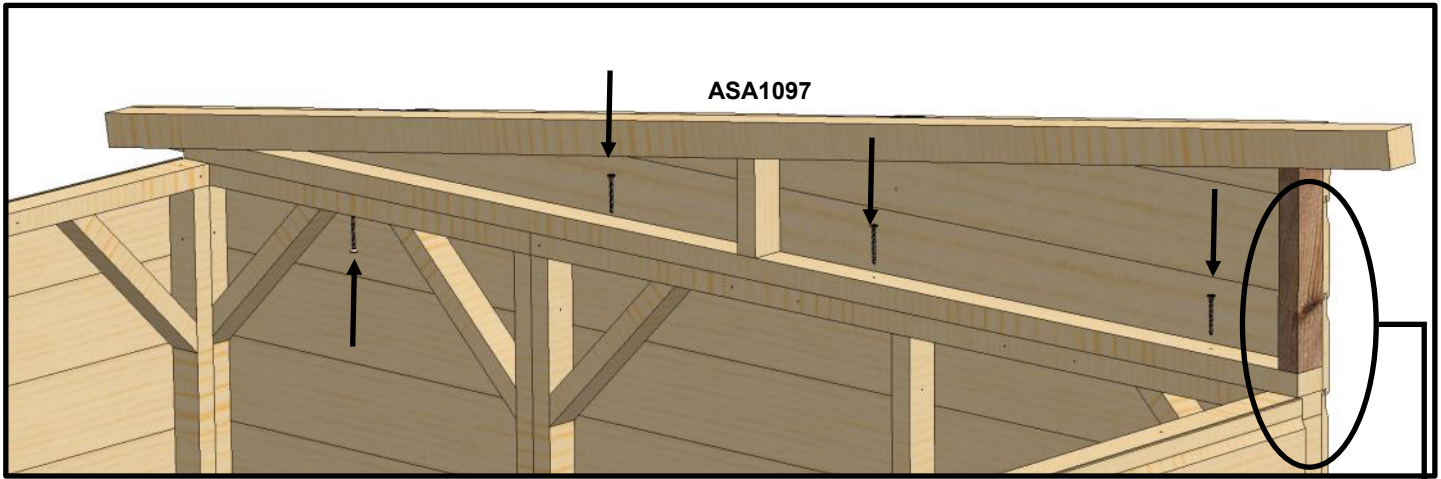

Put the **ASA1097** into place and line it up flush with the front (see image on the right). Ensure the T/G is flush with the front (see dotted line). You can use **50mm screws** to attach these to the **ASA1006/4** sides. You might find it easier to screw up from the underside. Make sure to drill 4mm pilot holes before screwing to avoid the wood from splitting.

6x12 example

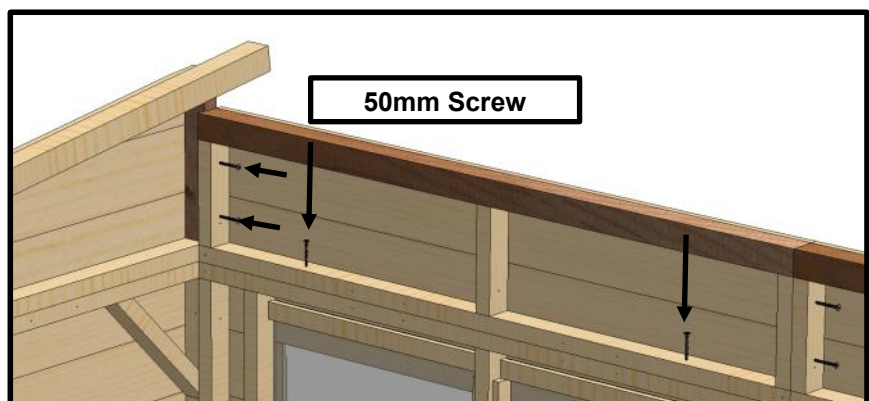
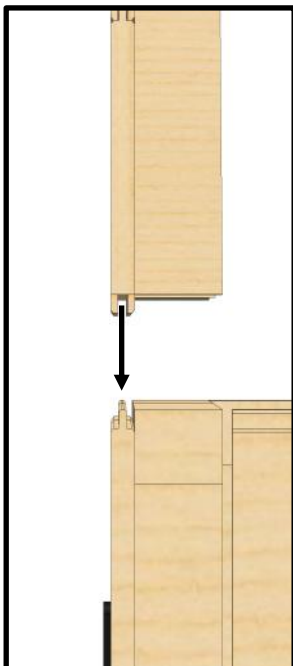
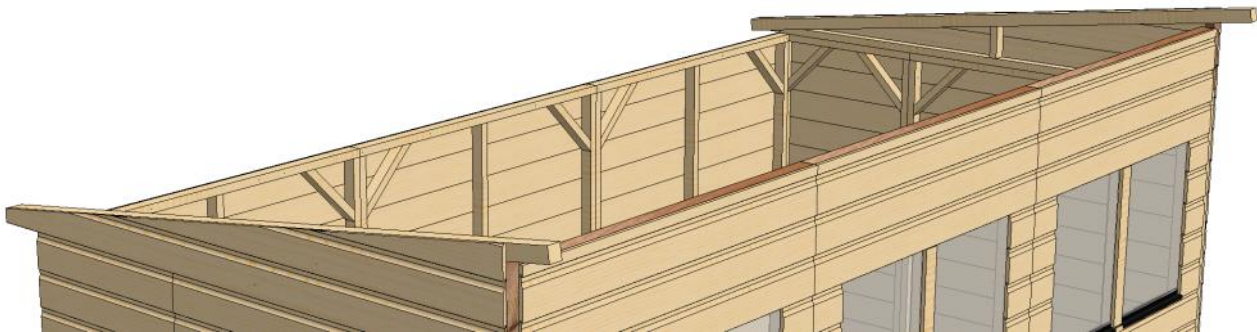
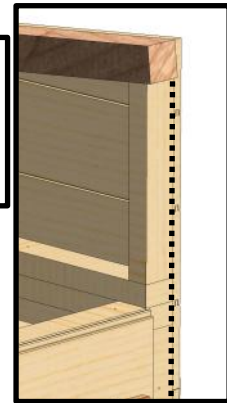

You can now install the ASA1094 Top Panels, make sure the tongue and groove slots. Again, use **50mm screws** to secure and drill 4mm pilot holes

The tongue on the cladding on the panels above will overhang 7mm at the bottom, this is so that it can slot perfectly into the groove on the panels below to create a neat join.

Roof Support Positioning

The roof support beams need to be spaced out in the correct position. See below for how to do this correctly

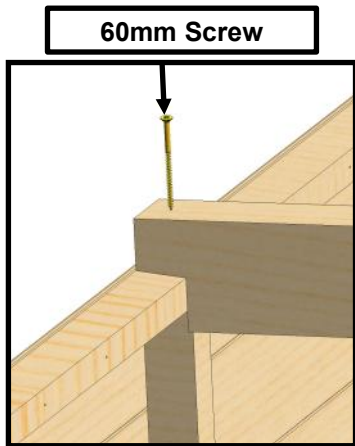
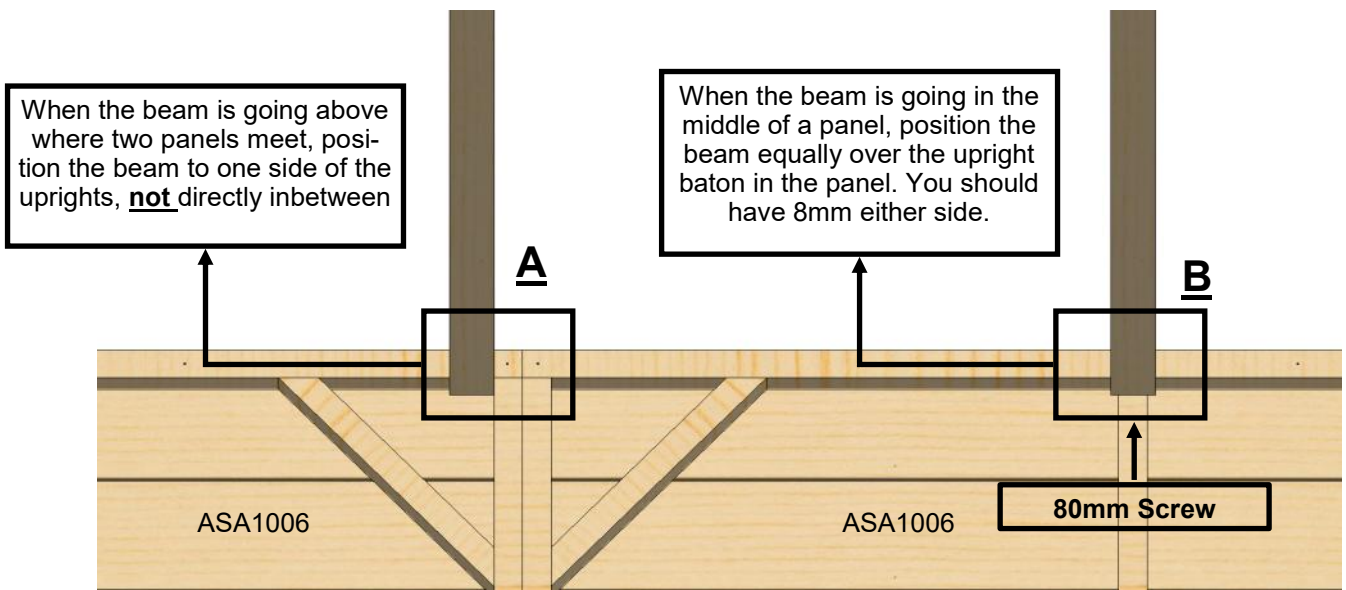

Once in position, secure down with an **80mm screw**. Make sure to drill 4mm pilot holes before screwing to avoid the wood from splitting. Repeat this process across the length of the building with the remaining beams you have.

For position A (above) use 2 x 60mm screws.
For position B (above) use 1 x 80mm screws

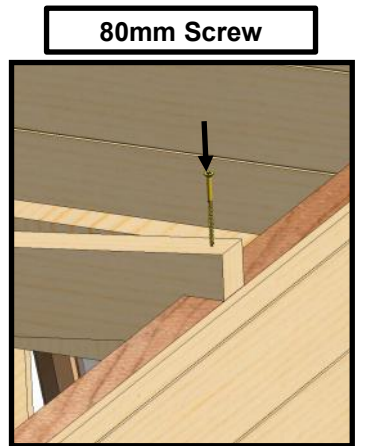

Pilot Hole size:

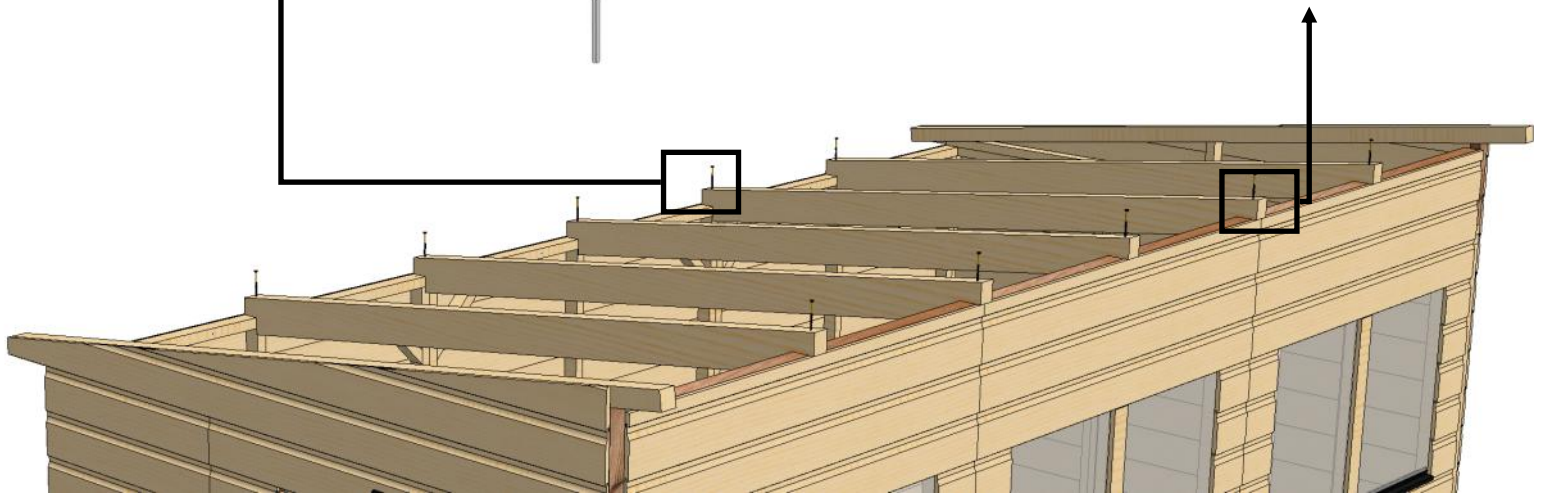

Roof Assembly

Get your first **ASA1099** roof panel and hang it over the top of the roof beam you have place and secure the other end to the ASA1096 pent panels. Use **x3 60mm screws** for each panel. The image below shows you how you should have your roof flush with your 'pent panels'.

NOTE: Ensure to always match the roof panels with the side panels. For example, a 2ft roof panel has to go above a 2ft side panel. The same principle applies for a 4ft side and roof panel



The top and ends of the roof should be flush with the top and ends of the pent side panels, see the dotted line on the image to the right

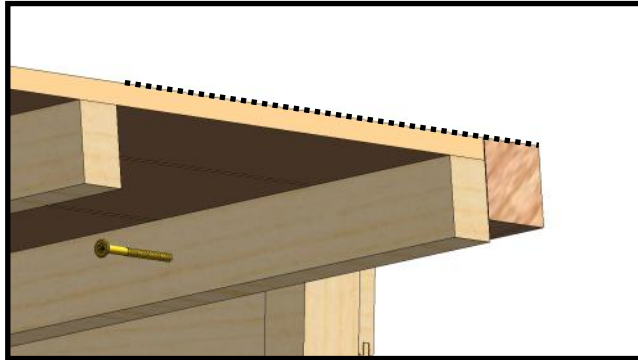

Repeat this process for the next roof panel for the back end, butt the roof panel up to the previously placed roof panel and ensure that it is flush at the back, like it is at the front. Once you are happy, secure to the side panels using **x3 60mm screws**. Where the two roof panels meet and there is no large roof support, you can use the **AS027** to secure the join even more, use **x4 50mm screws** for this.

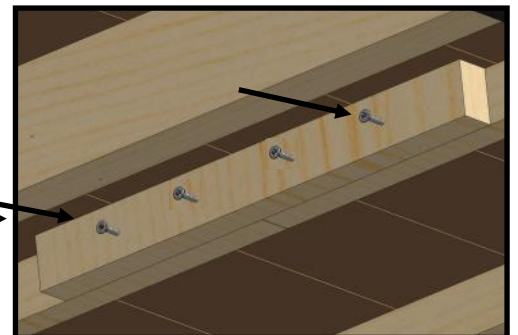
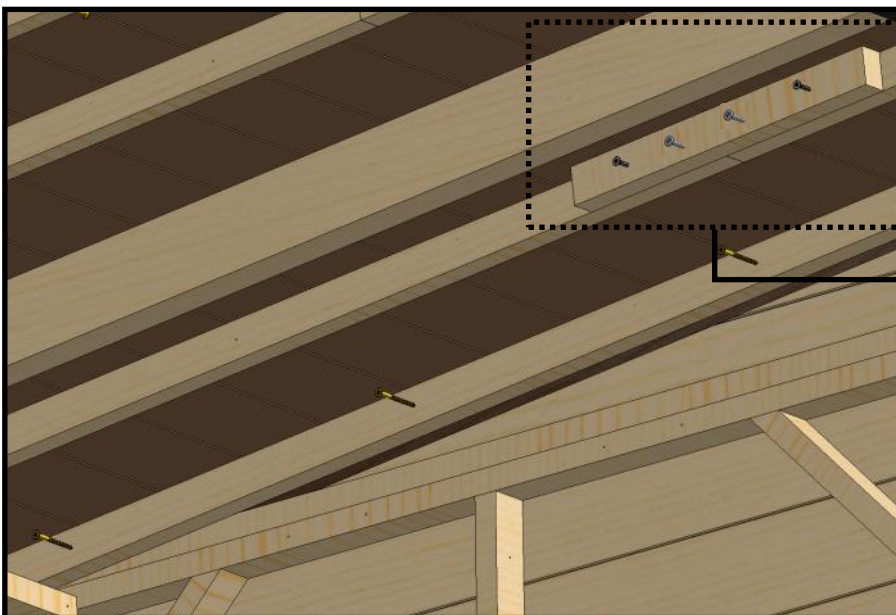

Roof Assembly

Now your first two panels are in place, you can work across the building inserting the rest of the panels. If you have placed roof supports correctly, as shown on page 14, your next roof panel along should fit into the gap. See below.

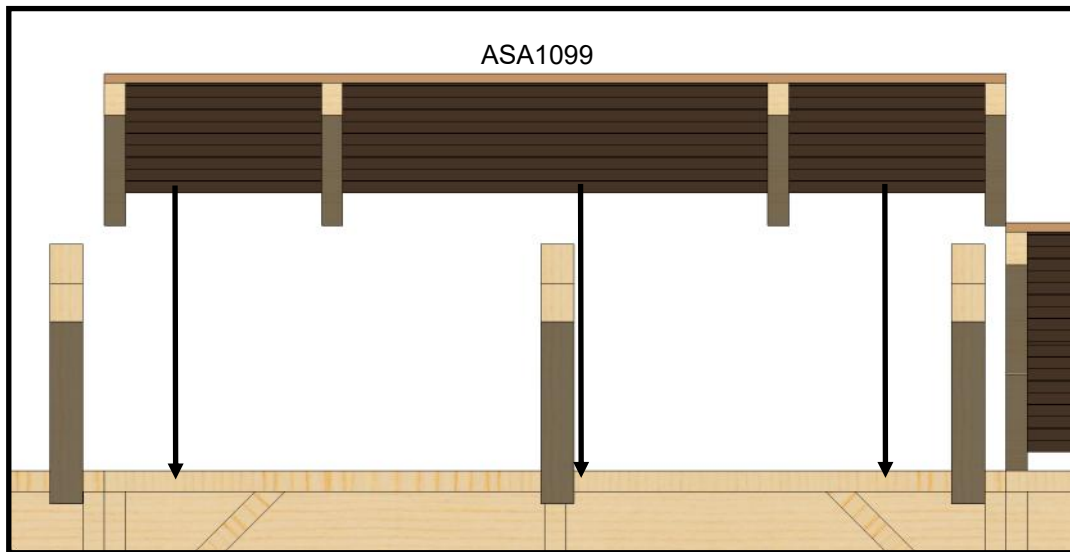

Once you have this panel slotted into place, fix to the roof supports/roof panels next to it using **x3 80mm screws** for each **ASA1099** Roof Panel, now you can do panel on the rear side.

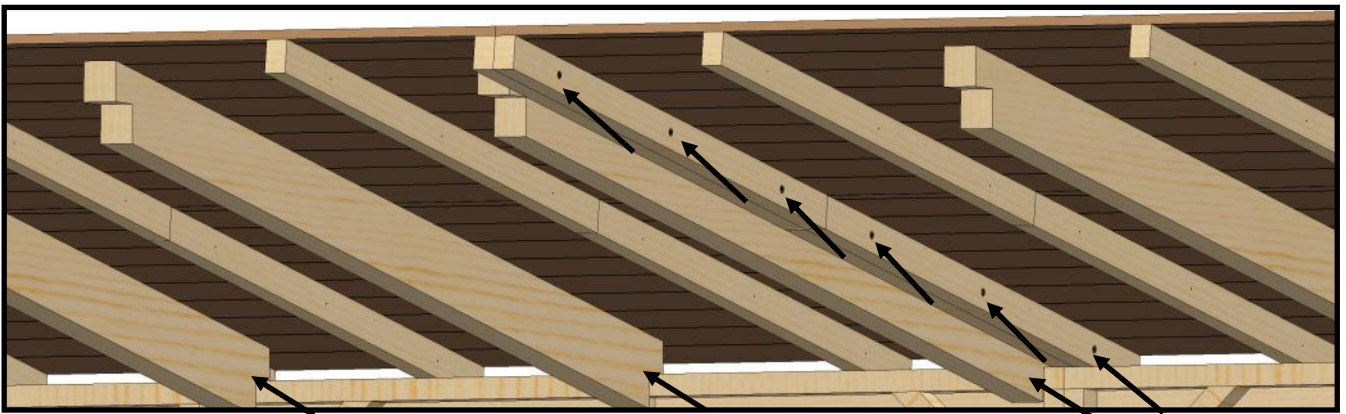

Repeat these steps across the building, ensuring all roof panels are properly secured to the roof joins and other roof panels next to them. Make sure to include the **AS027** where 2 roof panels meet in the middle to secure the join as previously seen. **Put 80mm screws diagonally (see arrows) at the top and bottom of the roof support**



Now it is time to attach your **AS145** piece to the outside of the building. These will go flush up to the batons on the **ASA1096** pent panels. Attach using **x5 60mm screws** for each part. Do this on both sides of the building too. They create a space for when you put the fascia so this step is **important**.



Roof Assembly

The next step is to attach your soffit boards. These are boards that go on the underside of the overhang on the roof at the front and back. You can use **35mm screws** to secure this to the roof. Make sure to screw into the roof bars when you do this. Repeat this across the building and at the back too. **On some sizes, you will need to trim the boards down to fit.**

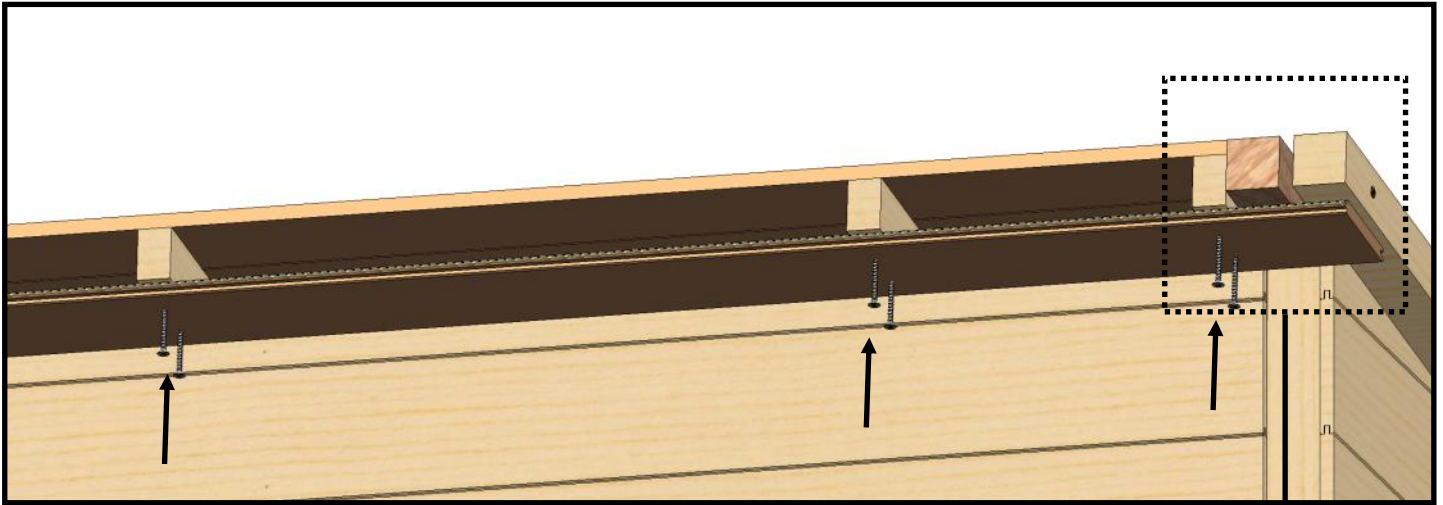

Make sure the edge of the soffit board is flush with the edge of the **AS145** you put in place previously. See the dotted line



Now you need to attach the **12x56 trim** at the back, this will cover up the gap at the back and also be something to nail your felt to when you get to that stage. You will need to cut the **AS024/AS172** to fit the space for your building. The sides of these will line up with the sides of the soffit boards. Attach these with **50mm screws**. Line the screws up with what you did on the soffits to ensure you screw into a roof bar.

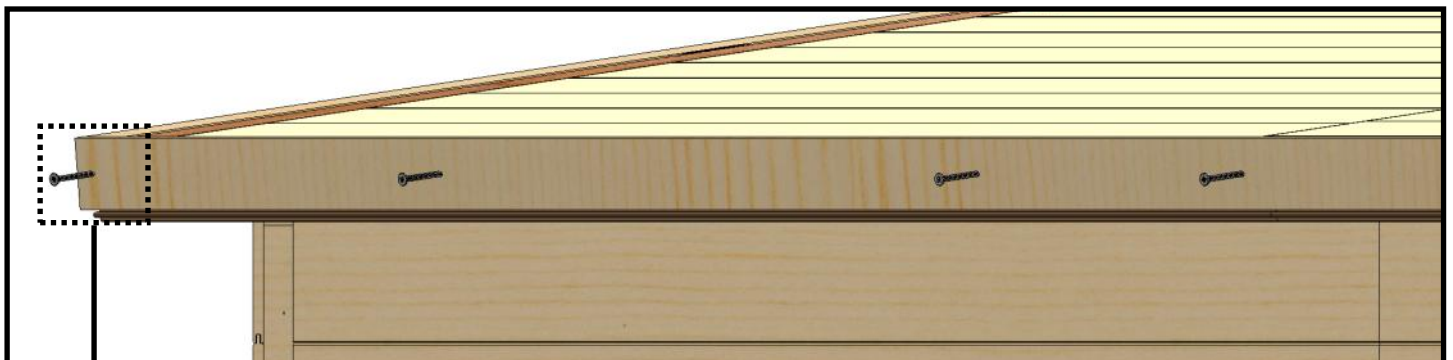

AS145

Trim

Aerial View

Felting

How to cut felt:

- Unroll out on the floor
- Mark correct length both sides of the roll using a tape measure.
- Use a straight edge as a ruler and cut with a Stanley knife
- Be cautious when cutting as if you cut one piece too big then the left overs will be too small.

Lengths to cut to	Felt 1m Wide	
	6x6	2125mm x3
	6x8	2725mm x3
	6x10	3325mm x3
	6x12	3925mm x3
	6x14	4525mm x3
	6x16	5121mm x3



Felt Clout
02-1675

Once you have cut your felt to the correct length for your building, roll it back up and place it on top of the roof. Its easier to move around if you roll it back up. Position the roll of felt at the back of the roof as that is the bottom of the slope, this is so when the next pieces overlap, the water wont run inside of the felt. Once its rolled out, space it out evenly so that it overhangs 50mm evenly over each gable end and around 2mm at the eaves of the roof. Now its in the correct position, place a Felt clout at each top edge to stop it from sliding. Pull it down so its nice and flat and begin to tac at the eaves.

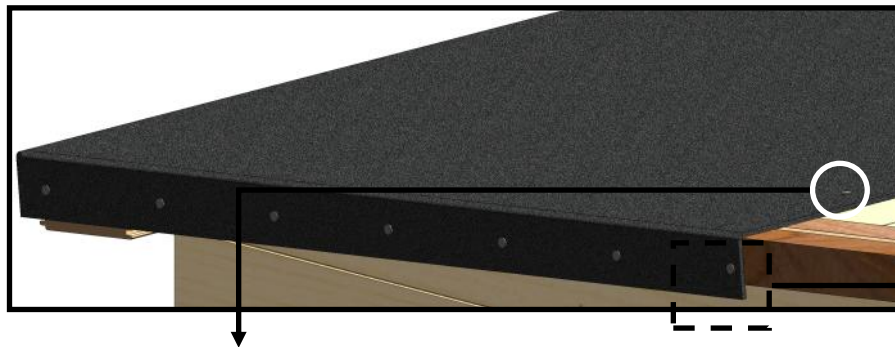
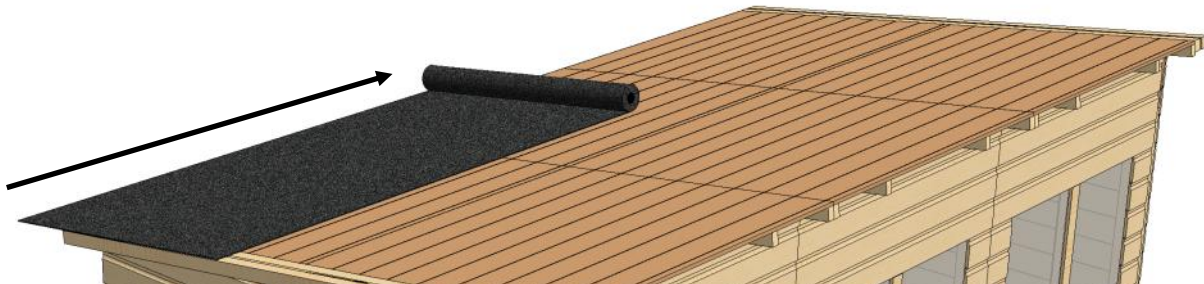

The felt should overhang slightly by about 2mm. It should not be tucked under or nailed 'up'. Also overhand the end by 50mm

Felt clout paced at the top (each side) to stop it from sliding down. You only need two or three felt clouts along the top as the next piece will overlap and be fully nailed down. Put some nails on the side but you will only need a few as the fascia board

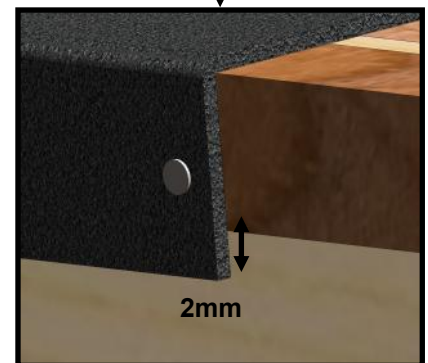

2mm

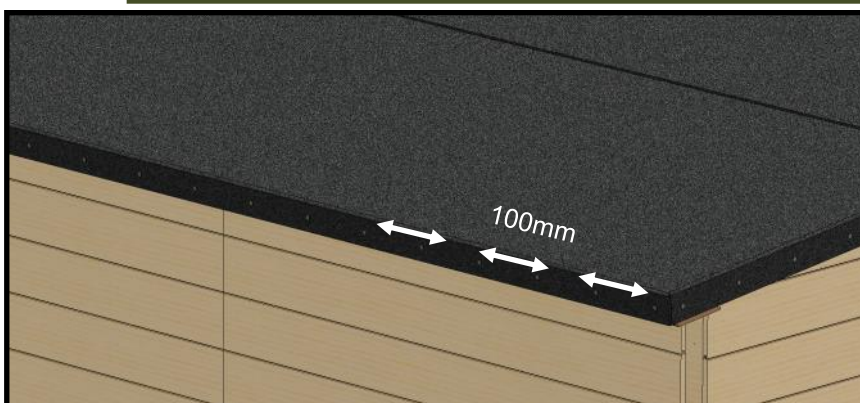

100mm

Put clout nails across the back spaced approx. every 100mm. You can nail down into the trim previously placed.

NOTE: Take extra caution when leaning on the roof to do the felting

Lay the next roll of felt across the top of that, there needs to be at least 100mm overlap between the layers. Put tacks every 100mm across the roof to secure it down and some down the side too, the side will get covered by a fascia board. Make sure you are still getting a 2mm overhang from the bar like before so the water can drip off.

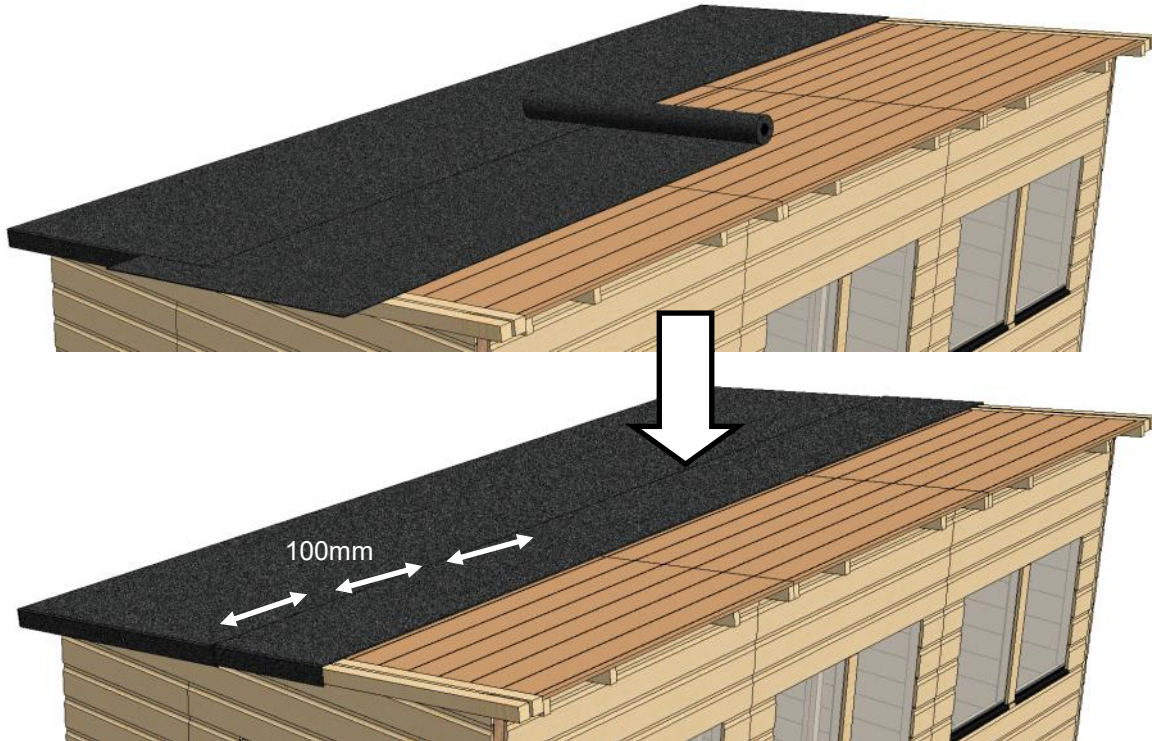

Lay the final roll of felt across the top of that. Make sure there is at least 100mm overlap between the layers. Put tacks every 100mm across the roof to secure it down and some down the side too, the side will get covered by a fascia board. Make sure you are still getting a 2mm overhang from the bar like before so the water can drip off. Put some tacks across the front, this will get covered by a fascia board. Line the tacks up with the screws in the soffits to make sure you are nailing into a roof bar

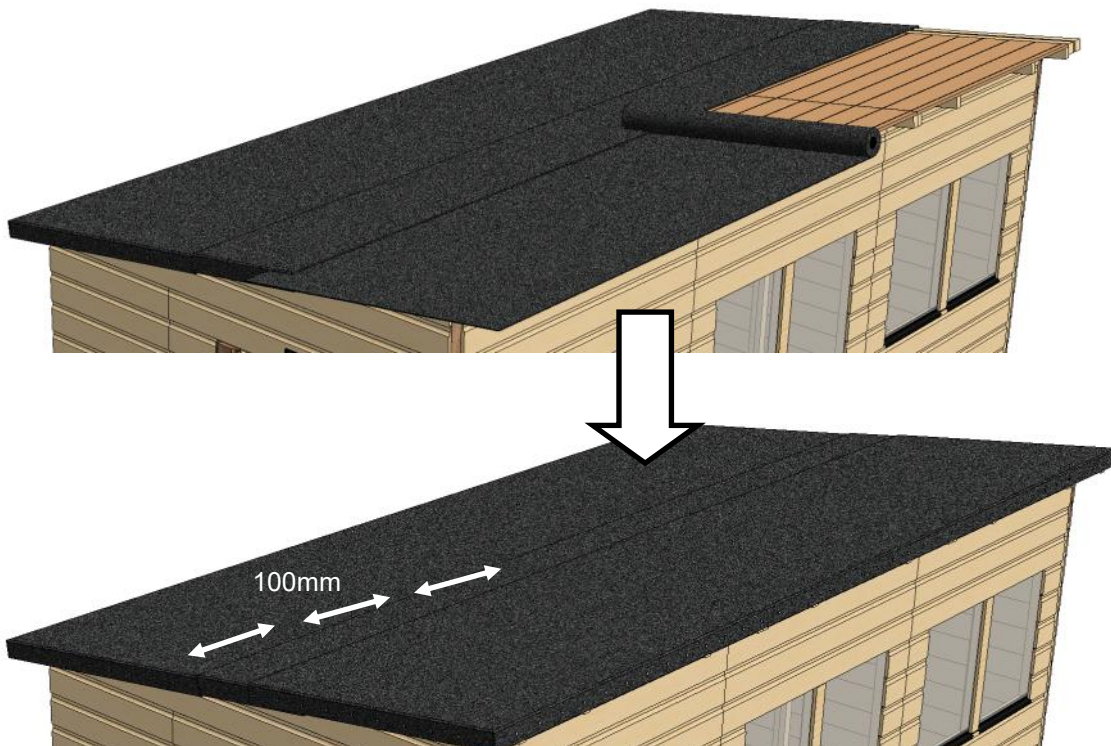

Facias and Capping

Attach the fascia boards with **x4 35mm screws** for each fascia board. The fascia on the sides should sit inside of the front fascia, see below. **Please note: There are no facias to go on the back**

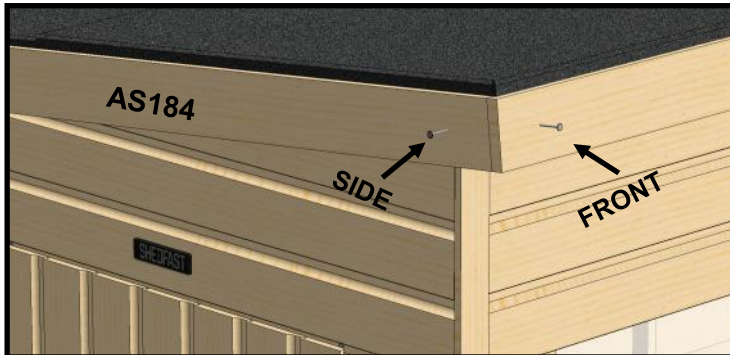

Use **AS184** Facias on each side

Your facias will be in different lengths for the front. Its best to make sure the facias match with where the joins in the panels are so the joins in the facias can also follow suit.

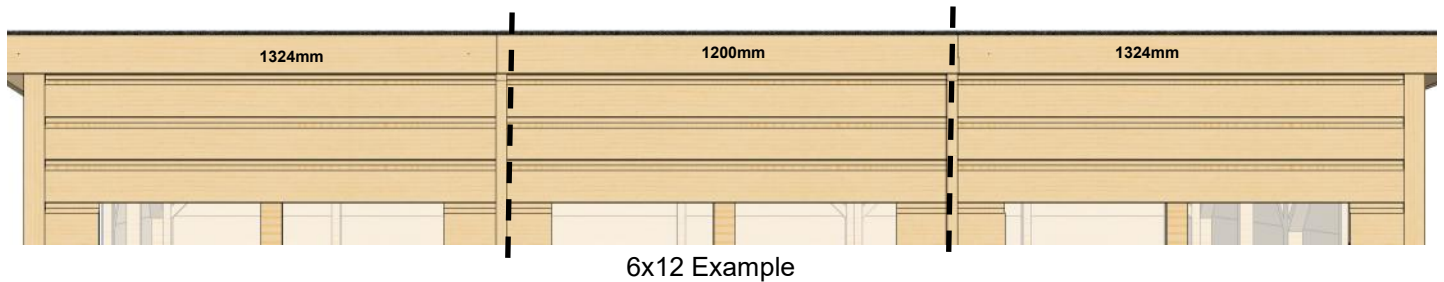

Now go round the building attaching the capping using **40mm galvanised nails**. The tallest pieces go on the front, and the smallest pieces go on the back

NOTE: You will need to cut the 12x56 trims for the side down to 1970mm.

40mm galvanised nails



4/5 nails on each piece of capping to properly secure them to the building

Fixing the sides to the floor

Now you have the roof fixed in position its now time to secure the sides to the floor. We do this last so that it is easier to square the roof up

Make sure the sides are equally spaced out from the floor (approx. 5mm from each side) and then put in your **60mm Screw 02-5001**

Place a screw down approximately every 2ft along the front, back and sides.

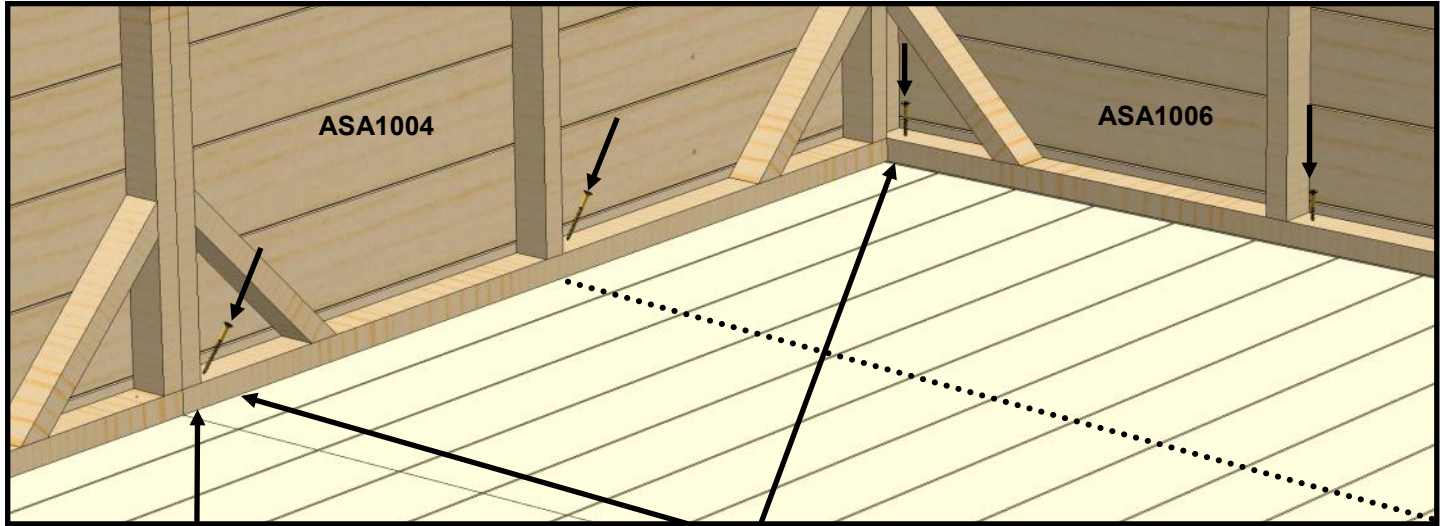



You will only need one screw at each joint

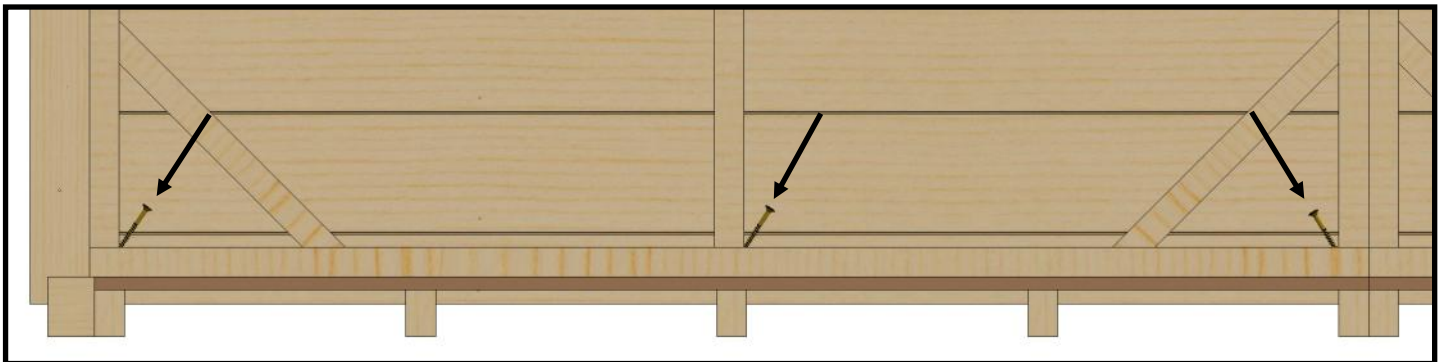





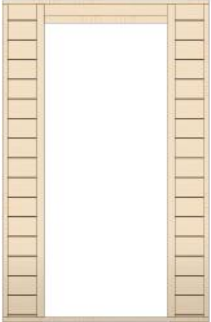
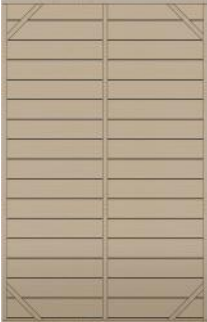

Some screws may need to be angled to catch the floor joists below.

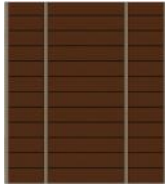

You can use the nails on the floor boards to see where the baton is underneath. Line your screws up with these nails when fixing the sides down to the floor

Standard Product Tables

	ASA1004 2ft Panel 600x1856	ASA1005 Single Door Panel 1200x1856	ASA1006 4ft Panel 1200x1856	ASA1011 4ft Window Panel 1200x1856	ASA1008 Single Door 740x1751
					
6x6	4	1	2	1	1
6x8	2		4	1	
6x10	4		4	1	
6x12	2		5	2	
6x14	4		5	2	
6x16	2		6	3	

	ASA1099 Roof 1200x1044	ASA1101 Roof 600x1044	ASA1096 6ft Left Pent Panel 336x2067	ASA1097 6ft Right Pent Panel 336x2067	ASA1001 4x6 Floor 1195x1790	ASA1024 6X2 Floor 600x1790	ASA1094 Pent Top Panel 249x1200	ASA1098 2ft Pent Top Panel 249x600
								
6x6	2	2	1	1	1	1	1	1
6x8	4	0			2	0	2	0
6x10	4	2			2	1	2	1
6x12	6	0			3	0	3	0
6x14	6	2			3	1	3	1
6x16	8	0			4	0	4	0







Bundles









	AS171X2	AS172X3	AS212	AS213	AS214	AS215	AS216	AS217	AS220
6x6	1	1	1	0	0	0	0	0	1
6x8	1	1	0	1	0	0	0	0	1
6x10	0	2	0	0	1	0	0	0	1
6x12	0	2	0	0	0	1	0	0	1
6x14	2	1	0	0	0	0	1	0	1
6x16	2	1	0	0	0	0	0	1	1

Smalls Packs

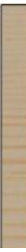
Bundle Contents

	ASSMA03	ASSMA21	ASSMA22	AS212	AS213	AS214	AS215	AS216	AS217	AS220
6x6	1	0	0	AS024 x3 AS175 x1 AS156 x1 AS060T x2 AS043T x2	AS024 x5 AS175 x2 AS060T x4	AS024 x6 AS174 x1 AS175 x1 AS156 x1 AS086T x2 AS060T x2 AS043T x2	AS024 x5 AS174 x1 AS175 x2 AS086T x2 AS060T x2	AS024 x7 AS174 x2 AS175 x2 AS156 x1 AS086T x4 AS060T x2 AS043T x2	AS024 x7 AS174 x2 AS175 x2 AS086T x4 AS060T x4	AS145 x2 AS184 x2
6x8	1	1	0							
6x10	1	1	1							
6x12	1	2	0							
6x14	1	2	1							
6x16	1	0	3							

	AS024 Trim 12x56 1876mm	AS172 Trim 12x56 2120mm	AS182 44x94 1837mm	AS184 Facia 2098mm	AS145 44x44 2089mm	AS009X2 56x44 17900mm
						
6x6	3	5	2	2	2	2
6x8	3	5	3			
6x10	4	6	4			
6x12	4	6	5			
6x14	5	7	6			
6x16	5	7	7			

	AS156 Facia 724mm	AS174 Facia 1200mm	AS175 Facia 1324mm	AS306 Shedfast Name Badge	AS027 44x28 400m m	AS060T 12x120 1300mm (Soffit)	AS086T 12x120 1200mm (Soffit)	AS043T 12x120 743mm (Soffit)
								
6x6	1	0	1	1	2	2	0	2
6x8	0	0	2		4	4	0	0
6x10	1	1	1		4	2	2	2
6x12	0	1	2		6	4	2	0
6x14	1	2	1		6	2	4	2
6x16	0	2	2		8	4	4	0

	Felt Codes					
	AS331 1m Wide X 5.4m Long roll	AS312 1m Wide X 6.6m Long roll	AS313 1m Wide X 8m Long roll	AS314 1m Wide X 10m Long roll	AS315 0.5m Wide X 4.1m Long roll	AS316 0.5m Wide X 5.4m Long roll
6x6	1	0	0	0	1	0
6x8	0	1	0	0	1	0
6x10	0	0	1	0	1	0
6x12	0	0	1	0	1	0
6x14	0	0	0	1	0	1
6x16	2	0	0	0	0	1

6ft WIDE PENT



Unpacking Pallet

The first thing you need to do is carefully unpack the pallet. Each panel is screwed to the diagonals at the top and bottom. Remove each panel, one at a time, by unscrewing the screws at the top and bottom. Take the panel off the pallet and place it somewhere safe.

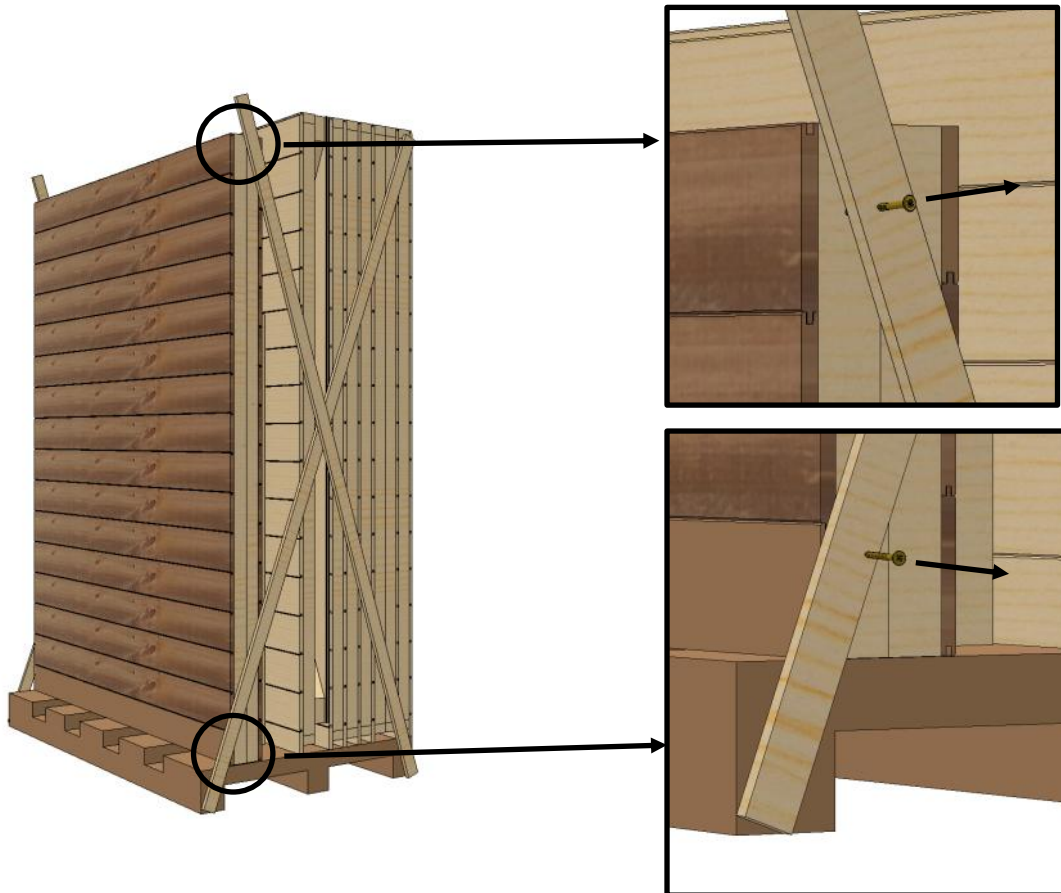

SHEDEFAST

www.greenhousepeople.co.uk

Call us on 01782 385400

The Greenhouse People Ltd, Unit 19 Blythe Park, Cresswell, Stoke-on-Trent, Staffordshire, ST11 9RD